

*Alta 4K series:
the LUT-based color processing and how to configure it*

Analog Way Worldwide

Europe & Africa: +33 (0)1 81 89 08 60

Middle East: +971 4 25 33 818

The Americas: +1 212 269 1902

Asia Pacific: +852 6882 7140

www.analogway.com

Introduction

In the last few years, the color management has dramatically evolved with new standards such as wide color gamut (BT. 2020) and high dynamic range (HDR) for even more impressive and accurate colors.

Most specifications of presentation switchers indicate they support wide color gamut and/or HDR but forget to explain that this only works in homogeneous workflows: all the sources and displays must use the same color space and dynamic range.

However, in real life, it is not unusual to mix contents with different color spaces (BT.709 and BT.2020) and/or different dynamic ranges (for instance, an HDR video mixed with an SDR presentations and spreadsheets). The simultaneous use of HDR display for main screens and SDR displays for auxiliary screens also becomes more and more frequent.

Another key point for some demanding applications is the ability to help the color calibrating of displays with advanced color corrections, that common settings (R/G/B levels, brightness, contrast and gamma) can't achieve.

The Alta 4K series with firmware v3.0 can now achieve all these conversions and corrections thanks to its brand-new color processing based on 3D look-up tables (LUT). This new architecture also offers a new chroma keying algorithm for even better results and ease of use.

After a few reminders, this document is intended to give a crucial understanding of how this new color processing works and how to configure it properly, as if not, this may lead to the opposite effect of the expected one.

Contents

1. Basic knowledge	7
1.1. Gamuts	7
1.2. RGB and YCbCr encodings	8
1.3. Dynamic Range	9
1.3.1. Standard Dynamic Range	9
1.3.2. High Dynamic Range.....	9
1.3.2.1. HDR10 Media Profile	9
1.3.2.2. Hybrid Log-Gamma	9
1.4. 3D look-up tables	11
1.5. Interfaces.....	13
1.5.1. DisplayPort	13
1.5.2. HDMI.....	13
1.5.3. SDI.....	13
1.5.4. ST2110	13
2. Color conversions and corrections.....	14
2.1. Why is conversion between BT.709 and BT.2020 needed?.....	14
2.2. Why is SDR/HDR conversion needed?	15
2.3. Why is Color Correction needed?	16
3. The Alta 4K series and its 3D LUT color processing.....	17
3.1. Architecture.....	17
3.2. Benefits.....	18
4. Configuring the color processing	19
4.1. Configuring input EDIDs	19
4.2. Configuring the internal color processing.....	20
4.3. Importing custom LUTs	21
4.3.1. Importing conversion LUTs.....	21
4.3.2. Importing correction LUTs.....	22
4.4. Configuring the conversions for inputs.....	23
4.4.1. Configuring the inputs with an SDR internal processing.....	24
4.4.2. Configuring the inputs with an HDR10 internal processing.....	24
4.4.3. Configuring the inputs with an HLG BBC internal processing	25
4.5. Configuring the color correction LUT for inputs	26
4.6. Configuring the conversions for outputs	27
4.6.1. Configuring the outputs with an SDR internal processing	28
4.6.1. Configuring the outputs with an HDR10 internal processing	28
4.6.2. Configuring the outputs with an HLG BBC internal processing	29

4.7. Configuring the color correction LUT for outputs..... 30

Figures

Figure 1: CIE 1931 chromaticity diagram with SDTV, HDTV and UDTV gamuts	7
Figure 2: Common YCbCr chroma subsampling schemes	8
Figure 3: HLG transfer function vs SDR transfer function	10
Figure 4: Example of a 9x9x9 RGB LUT	11
Figure 5: Trilinear interpolation (left) VS Tetrahedral interpolation (right)	12
Figure 6: Non-conversion from ITU-R BT.709 to ITU-R BT.2020	14
Figure 7: Non-conversion from ITU-R BT.2020 to ITU-R BT.709	14
Figure 8: Non-conversion from SDR (left) to HDR10 (right) leading to burned colors	15
Figure 9: Non-conversion from HDR10 (left) to HLG (right) leading to dimmed colors	15
Figure 10: Dynamic Range and Color Space conversions in the Alta 4K series	17
Figure 11: Example of heterogeneous workflow with a basic switcher	18
Figure 12: Example of heterogeneous workflow range setup with an Alta 4K system	18
Figure 13: Default EDIDs for HDR support	19
Figure 14: Status of Input 5 receiving an HDR10 1000nits content	19
Figure 15: Example of a Color Processing configuration for HDR10	20
Figure 16: Example of source statuses	20
Figure 17: Hovering over an empty slot	21
Figure 18: Upload form for a conversion LUT	21
Figure 19: Slot of a conversion LUT after upload	22
Figure 20: Upload form for a correction LUT	22
Figure 21: Slot of a correction LUT after upload	22
Figure 22: Forcing the dynamic range of an input	23
Figure 23: Selecting an input custom conversion LUT	23
Figure 24: Standard manual color correction (left) vs LUT-based color correction (right)	26
Figure 25: Forcing the color space and dynamic range of an output	27
Figure 26: Selecting an output custom conversion LUT	27
Figure 27: Standard manual color correction (left) vs LUT-based color correction (right)	30

Reference List

- CTA-861-G (11/2016) A DTV Profile for Uncompressed High Speed Digital Interfaces
- ITU-R BT.601-7 (03/2011) Studio encoding parameters of digital television for standard 4:3 and wide-screen 16:9 aspect ratios
- ITU-R BT.709-6 (6/2015) Parameter values for the HDTV standards for production and international programme exchange
- ITU-R BT.2020-2 (10/2015) Parameter values for ultra-high definition television systems for production and international programme exchange
- ITU-R BT.2100-0 (07/2016) Image parameter values for high dynamic range television for use in production and international programme exchange
- ITU-R BT.2390-9 (03/2021) High dynamic range television for production and international programme exchange
- ITU-R BT.2408-4 (03/2021) Guidance for operational practices in HDR television production
- SMPTE ST 425-1:2017 Source Image and Ancillary Data Mapping for the 3Gb/s Serial Interface
- SMPTE ST 2081-10:2018 2160-line and 1080-line Source Image and Ancillary Data Mapping for 6G-SDI
- SMPTE ST 2082-10:2018 2160-line and 1080-line Source Image and Ancillary Data Mapping for 12G-SDI
- SMPTE ST 2084:2014 High Dynamic Range Electro-Optical Transfer Function of Mastering Reference Displays
- SMPTE ST 2086:2018 Mastering Display Color Volume Metadata Supporting High Luminance and Wide Color Gamut Images
- SMPTE ST 2110-20-2017 Professional Media Over Managed IP Networks: Uncompressed Active Video
- VESA DisplayPort (DP) Standard: version 1.2, 1.3 and 1.4
- 3D LUT interpolation - JD Vandenberg - August 28th 2019
- Cube LUT Specification Version 1.0, Adobe – September 2013

1. Basic knowledge

1.1. Gamuts

The gamut is the whole range of colors managed by a device. Computer graphics and video systems handle a subset of the color spectrum the human eye can see. Models of this spectrum were created in 1931 by the International Commission on Illumination and are known as CIE 1931 color spaces (CIE is the abbreviation of French name “Commission Internationale de l’Eclairage”, “International Commission on Illumination” in English).

- The color space of SDTV system was specified in **ITU-R BT.601** and covers 35% of the CIE 1931 color space.
- The color space of HDTV system was specified in **ITU-R BT.709**. It is very close to the color space of ITU-R BT.601 and covers 35.9% of the CIE 1931 color space.
- The color space of UHDTV system is specified in **ITU-R BT.2020** and covers 75.8% of the CIE 1931 color space. It is called **Wide Color Gamut**.

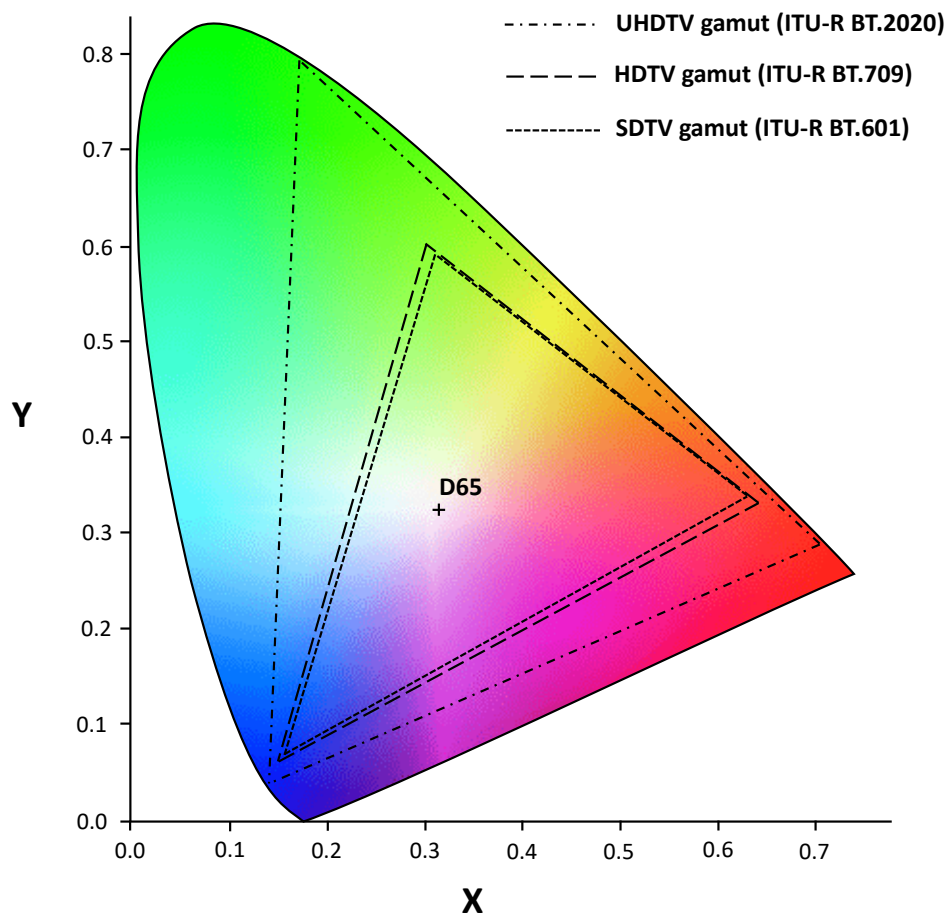

Figure 1: CIE 1931 chromaticity diagram with SDTV, HDTV and UDTV gamuts

IMPORTANT: there are also other color spaces such as DCI-P3 or sRGB with gamuts larger than ITU-R BT.709 but smaller than ITU-R BT.2020. They are currently not supported by the Alta 4K series.

1.2. RGB and YCbCr encodings

The three ITU-R (BT.601, BT.709 and BT.2020) specify the digital representations of the colors. They define RGB (Red-Green-Blue) and YCbCr (Luma/Blue Chroma/Red Chroma) encodings and the conversions between these two encodings.

IMPORTANT: These encodings are specific to each of these ITU-R. It means that, given a bit depth, a color of the CIE 1931 with given X and Y coordinates won't have the same RGB or YCbCr values.

If RGB seems to be the more intuitive way to encode a color, YCbCr is very interesting for it has interesting properties deeply related to human vision. As human eye is more sensitive to luma changes, it is possible to subsample the chroma components of an image/video signal to save space/bandwidth. It is also possible to apply filters (low-pass, sharpness...) on the luma component only and therefore, save resources (computation time and/or hardware resources).

Usually, a Jx2 pixel area is used to represent the chroma subsampling scheme and the "J:a:b" notation is used:

- "J" the number of luma information per line. It is usually 4.
- "a" the number of chroma information on the first line
- "b" the number of chroma information on the second line. When b=0, the chroma-information of the first line is used.

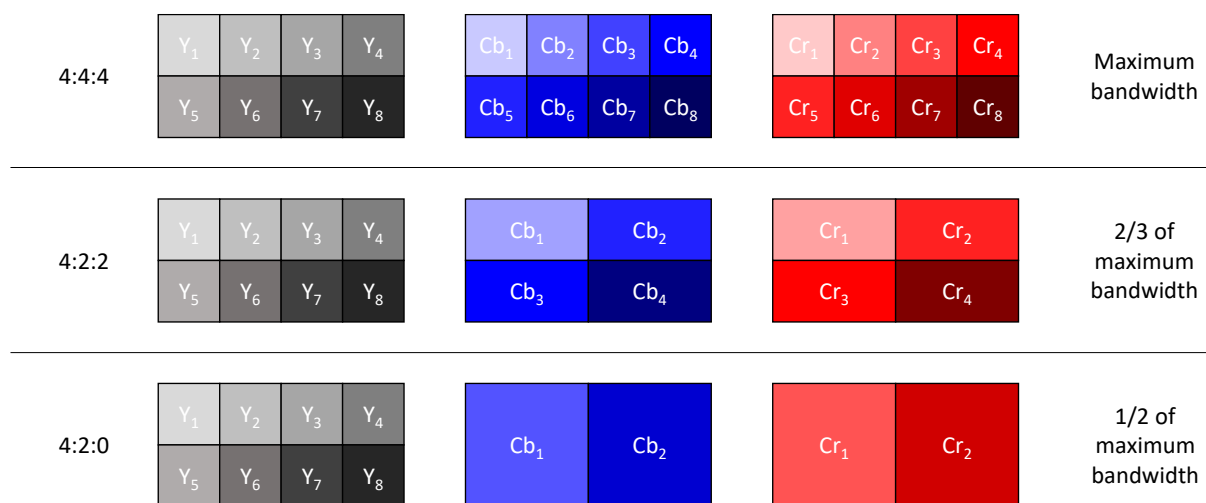

Figure 2: Common YCbCr chroma subsampling schemes

1.3. Dynamic Range

1.3.1. Standard Dynamic Range

SDR video is a technology that uses gamma curves to convert light intensity to electrical signal, and vice versa. Based on the limitations of CRT displays, the maximum luminance of video display is 100 cd/m² (or nits).

The opto-electronic transfer function (OETF) is specified for each color space: ITU-R BT.601, ITU-R BT.709 and ITU-R BT.2020.

The electro-optical transfer function (EOTF) is specified in ITU-R BT.1886.

1.3.2. High Dynamic Range

There are many HDR standards, but this chapter mainly focuses on the two standards specified in the ITU-R BT.2100 and supported by the Alta 4K series:

- Perceptual Quantizer (**PQ**)
- Hybrid Log-Gamma (**HLG**)

IMPORTANT: HDR is often deeply tied to ITU-R BT.2020 and 10bit color depth. However, it can be used with ITU-R BT.709, 8-bit color depth and lessened results...

1.3.2.1. HDR10 Media Profile

Commonly called **HDR10**, it was announced by the CTA (Consumer Technology Association, formerly CEA Consumer Electronics Association) in 2015. HDR10 uses:

- the Wide Color Gamut specified in ITU-R BT.2020
- a **10-bit** color depth (30 bits per pixel)
- the **PQ** transfer function specified in the **SMPTE ST 2084**. It is a nonlinear electro-optical transfer function (EOTF) supporting a luminance range of 0-10000cd/m² (or nits).
- static metadata to send information about the data content. These metadata are specified in **SMPTE ST 2086** and **CTA-861-G**. Among the metadata information, two of them are important to know:
 - o Maximum Frame-Average Light Level (**MaxFALL**): contains the highest frame-average light level in of whole content.
 - o Maximum Content Light Level (**MaxCLL**): contains the light level of the brightest pixel in the whole content.

1.3.2.2. Hybrid Log-Gamma

The HLG profile was jointly developed by the **BBC** (British Broadcasting Corporation) and the **NHK** (Nippon Hōsō Kyōkai, Japan Broadcasting Corporation in English).

It is a backwards-compatible HDR standard as it is still compatible with existing transmissions standards regarding SDR.

HLG uses:

- the Wide Color Gamut specified in ITU-R BT.2020
- a bit depth of **10 bits** (30 bits per pixel)
- a nonlinear transfer function composed of:
 - o A **gamma** curve in its lower half of signal values,
 - o A **logarithmic** curve in its upper part.

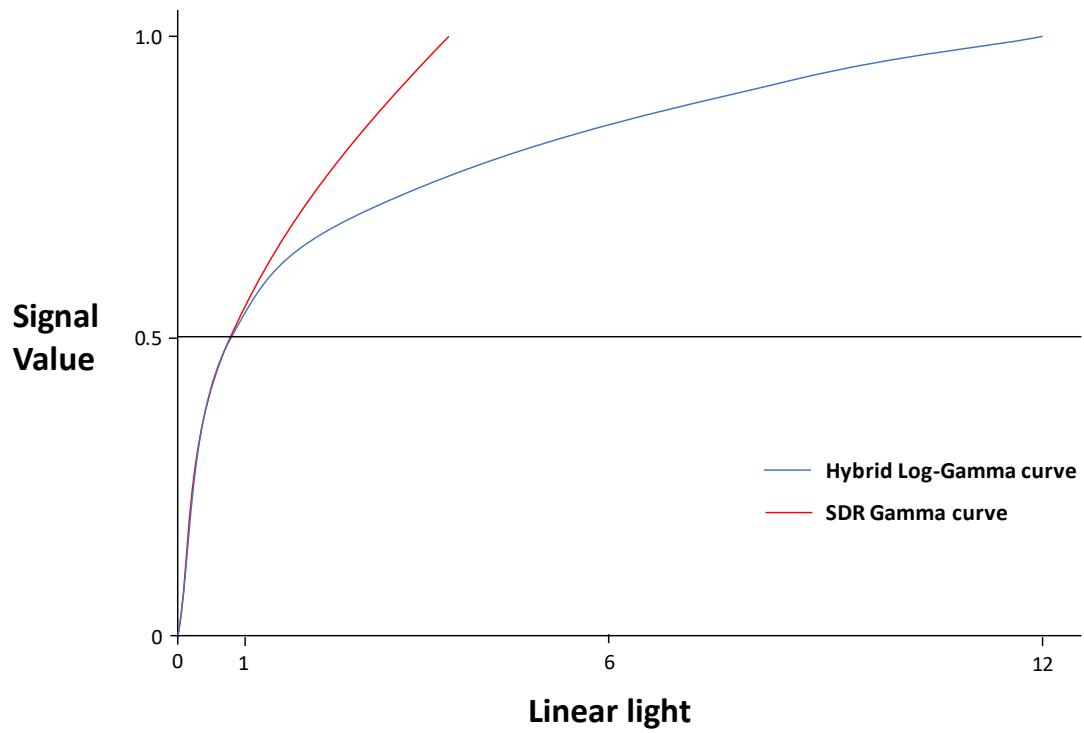

Figure 3: HLG transfer function vs SDR transfer function

HLG does not require metadata except the one specifying HLG profile is used.

1.4. 3D look-up tables

Converting a value to another one using a mathematical formula can consume a lot of computation time, especially when the conversion is not linear. That may be a huge problem for real-time application. A common solution is to use a table of precomputed values to map the input value: it just uses memory and dramatically reduces the computation time. A 3D look-up table (3D LUT) is a table that uses an input triplet to compute an output value.

Therefore, 3D LUTs are very well adapted to map color spaces to others. But mapping each input color to its output color would cost too much memory to store and parse (for a 10-bit signal, more than 4GB). Therefore, the look-up table is subsampled.

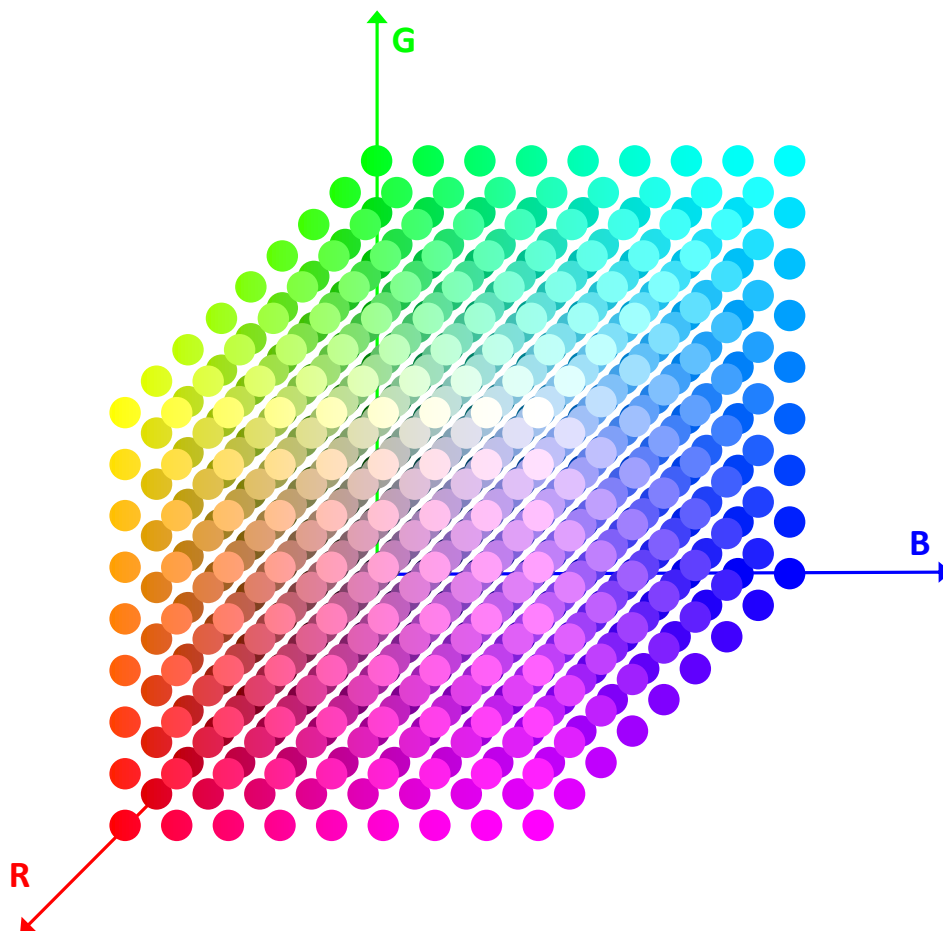

Figure 4: Example of a 9x9x9 RGB LUT

To find the output color of an input color that doesn't exist in the table, an interpolation algorithm is used.

There are different types of algorithms: from basic trilinear interpolation, using the 8 vertices of the cube containing the input triplet, to tetrahedral interpolation based on tetrahedrons. This latest solution is far more accurate as it only uses the four closest vertices (a tetrahedron):

- It limits the influence of the others, especially in areas where the output colors have high-dynamic variations.
- It allows to reduce the size of the LUTs.

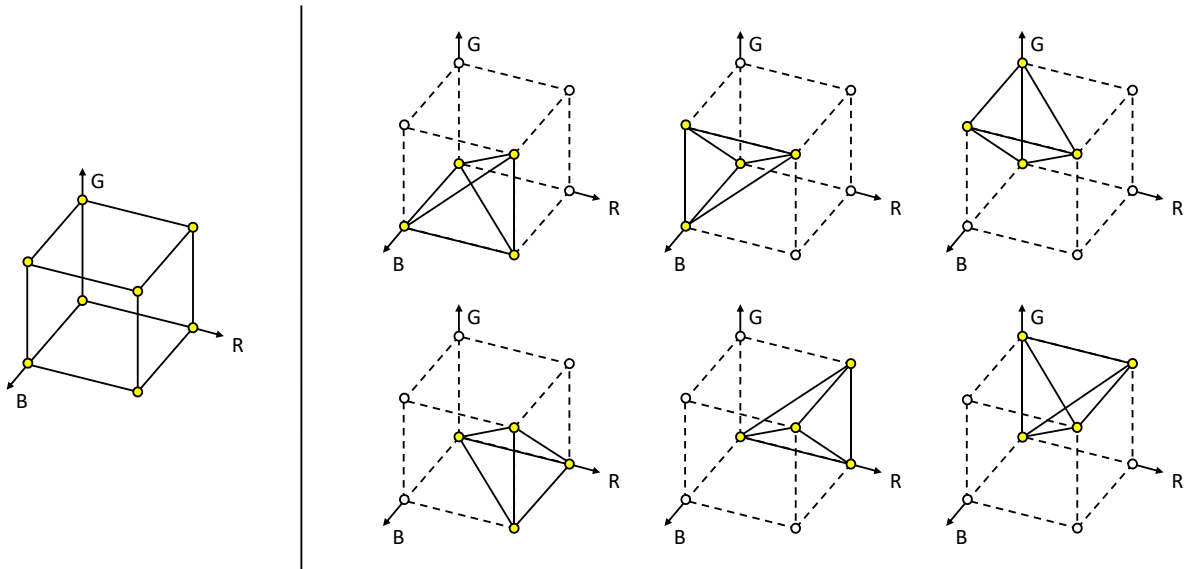

Figure 5: Trilinear interpolation (left) VS Tetrahedral interpolation (right)

LUTs can be mathematically combined and interpolated to create a single LUT if the consistency of their input and output data types is respected. This property is very important when several conversions/corrections must be achieved simultaneously: in our case color space conversion, dynamic range conversion and color correction.

For best results, the Alta 4K series uses 33x33x33 10-bit 3D LUTs with a tetrahedral interpolation.

1.5. Interfaces

1.5.1. DisplayPort

ITU-R BT.2020 support is specified in version 1.3 of DisplayPort and HDR10 support is specified in version 1.4 of DisplayPort.

These features are integrated in the DPCD (DisplayPort Configuration Data).

IMPORTANT: It is possible to implement a DisplayPort 1.2 interface with a DPCD version 1.4 and therefore to support ITU-R BT.2020 and HDR10 with static metadata. But it cannot be called DP1.4 as its bandwidth is limited to 21.6Gbits/s (17.28Gbits/s bandwidth available) and does not support other features such as DSC (Display Stream Compression).

Consequently, the Alta 4K series has DP1.2 interfaces but **does support ITU-R BT.2020 and HDR10** up to 4K 60Hz 10bit 4:4:4.

1.5.2. HDMI

HDMI 2.0 supports the color space of **ITU-R BT.2020**. But support of HDR with static metadata only comes in version 2.0a. This version included the support of HDR10. Later, HLG was added in specification of **HDMI 2.0b**.

IMPORTANT: Due to HDMI 2.0's 18Gbits/s bandwidth, supporting both 4K/UHDTV and a 10-bit data format needed for HDR implies to either subsample the chroma data or reduce the frame rate:

- 3840 x 2160 @ 50/60Hz 10bit 4:2:2 or 4:2:0
- 3840 x 2160 @ 25/30Hz 10bit 4:4:4

The Alta 4K series integrates HDMI 1.4 on input 1 and 2 (without HDR) and HDMI 2.0b on the other HDMI input.

1.5.3. SDI

After several evolutions of the standards, HDR (HDR10 and HLG) and ITU-R BT2020 are supported by:

- 3G-SDI (SMPTE ST 425-1:2017)
- 6G-SDI (SMPTE ST 2081-10:2018)
- 12G-SDI (SMPTE ST 2082-10:2018).

The HDR profile is available in the payload identifier's byte 2 specifying the transfer characteristics.

The ITU-R BT.2020 profile is available in the payload identifier's byte 3 specifying the colorimetry.

The Alta 4K series supports ITU-R BT 2020 and HDR for 3G-SDI, 6G-SDI and 12G-SDI.

1.5.4. ST2110

ST 2110 interfaces support HDR. According to SMPTE 2110-20:2017, it is possible to specify in the Media Type Parameters:

- the color space in the Colorimetry parameter
- the dynamic range in the Transfer Characteristic System parameter

2. Color conversions and corrections

2.1. Why is conversion between BT.709 and BT.2020 needed?

A color of the CIE 1931 color space encoded in ITU-R BT.709 doesn't have the same RGB or YCbCr values in ITU-R BT.2020. And reciprocally, the same values in ITU-R BT.709 and ITU-R BT.2020 may represent the same color (X/Y values) in the CIE 1931

For instance, a vertex of the ITU-R BT.2020 triangle has the same RGB or YCbCr code as the corresponding vertex in the ITU-R BT-709 triangle but doesn't represent the same color in the CIE 1931 color space.

As color gamuts specified by ITU-R BT.601 and ITU-R BT.709 are quite close, not converting colors between them does not lead to a clearly visible difference of colors. But ITU-R BT.2020 is more than twice larger than ITU-R BT.709:

- Not converting colors from ITU-R BT.709 to ITU-R BT.2020 modifies their X and Y coordinates: there is a gamut "expansion" altering colors that seems more vivid.

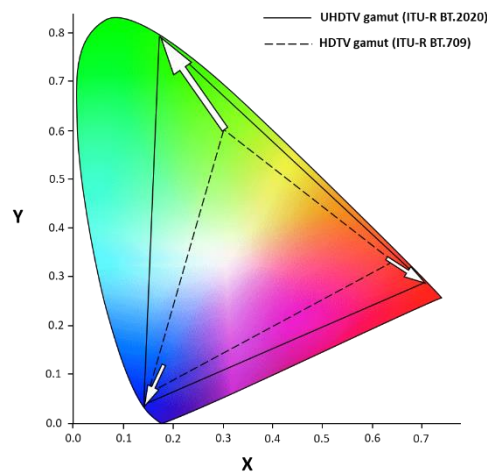

Figure 6: Non-conversion from ITU-R BT.709 to ITU-R BT.2020

- At the opposite, not converting from ITU-R BT.2020 to ITU-R BT.709 causes a gamut shrink and some colors (those already in the ITU-R BT.709 triangle) may look washed out.

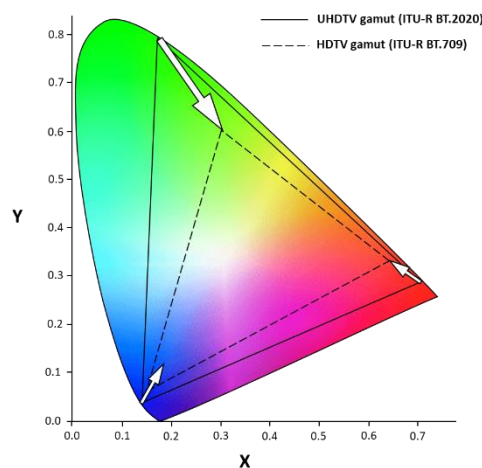

Figure 7: Non-conversion from ITU-R BT.2020 to ITU-R BT.709

For ITU-R BT.709 to ITU-R BT.2020 conversion, the goal is to calculate the new color codes, so the colors' X&Y values remain unchanged.

For ITU-R BT2020 to ITU-R BT.709 conversion, the main difficulty is to find a compromise between the two following constraints:

- The conversion must calculate the new codes of colors existing in both color spaces, so their X&Y values remain unchanged.
- The conversion must interpolate the value of colors only existing in ITU-R BT2020 (outside ITU-R BT.709 triangle) toward an ITU-R BT.709 color without breaking color gradients too much.

2.2. Why is SDR/HDR conversion needed?

Most of presentation systems claiming to support HDR processing implement a passthrough management: the whole workflow must be homogeneous, and the same dynamic range standard is used from the sources to the display systems.

As soon as one of the contents or displays uses a different standard, some problems appear:

- sources with different dynamic range standards cannot be mixed properly together,
- an output content cannot be displayed properly on a display not supporting its dynamic range.



Figure 8: Non-conversion from SDR (left) to HDR10 (right) leading to burned colors



Figure 9: Non-conversion from HDR10 (left) to HLG (right) leading to dimmed colors

IMPORTANT:

- SDR to HDR conversion does **NOT** improve the colors of an SDR content.
- When properly converted, an SDR content should be displayed on an HDR display identically as it is on an SDR one.

2.3. Why is Color Correction needed?

Some high-end applications require really accurate color rendering and therefore, their displays must be calibrated.

In a nutshell, a dedicated software tool is used to display color test patterns that are measured with a spectrophotometer/colorimeter. Using a device-independent color space ($L^*a^*b^*$ or XYZ for instance), the software can generate an ICC profile of the display and then compute a color correction table.

Another interesting and playful application of correction LUTs is to modify the colors of a video:

- Reduce the number of colors,
- Remap a range of colors to another one (for instance, green becomes orange to turn spring trees into autumn trees)
- Invert colors ...

Color correction look-up tables can be assigned to any input or output of an Alta 4K unit.

3. The Alta 4K series and its 3D LUT color processing

3.1. Architecture

From firmware v1.0, the Alta 4K series embed an image processing based on 33x33x33 3D LUTs for some inputs (please refer to chapter 4.4) and all outputs.

This version takes also full benefits of this architecture to perform in real-time and without any additional latency:

- dynamic range and color space conversions,
- color corrections.

Just like for the frame rate and the internal rate, the sources must be converted to the same color space and dynamic range (called **Internal Profile**) so they can be mixed properly.

Then all the outputs can be converted independently to another color space and dynamic range.

By default, the Alta 4K series integrates embedded LUTs that are used with the Auto mode settings. Some of these LUTs were developed by the BBC (British Broadcast Corporation) to ensure a high level of accuracy during conversions.

However, it is also possible to use custom LUTs. They must be imported in one of the three LUT libraries depending on their use:

- **Conversion LUTs:** their input/output dynamic ranges and color spaces must be specified to characterize the conversion.
- **Correction LUTs:** their input/output dynamic ranges and color spaces are the same, they change the color mapping.

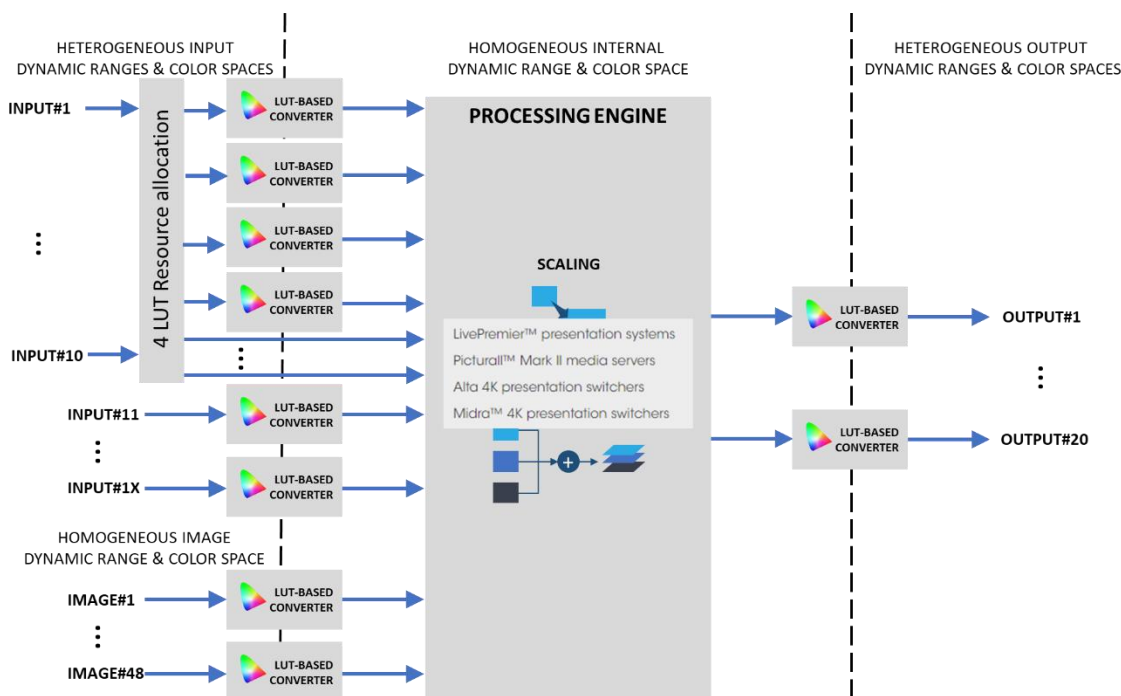

Figure 10: Dynamic Range et Color Space conversions in the Alta 4K series

IMPORTANT: On Alta 4K series, only 4 LUT resource are available from the inputs 1 to 10. The remaining inputs have their one resource allocated.

3.2. Benefits

Working with an Alta 4K series switcher eliminates the subsequent drawbacks:

- additional cost of the external converters,
- additional unmanaged latency,
- additional risks of failure (power supplies, cabling...).

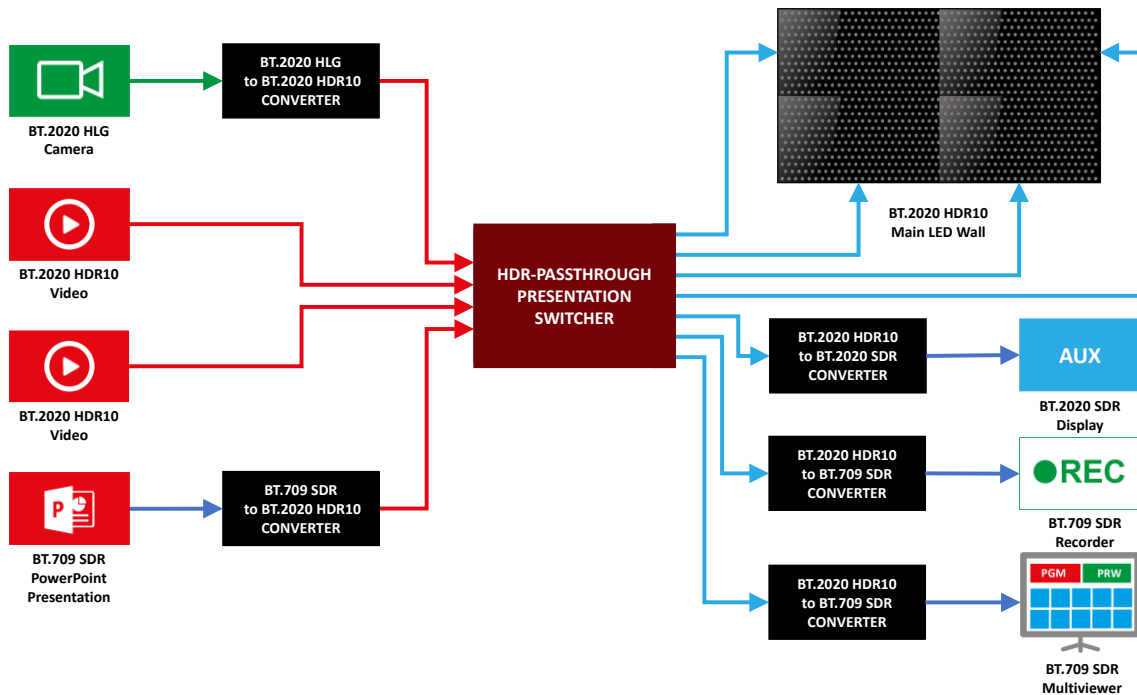

Figure 11: Example of heterogeneous workflow with a basic switcher

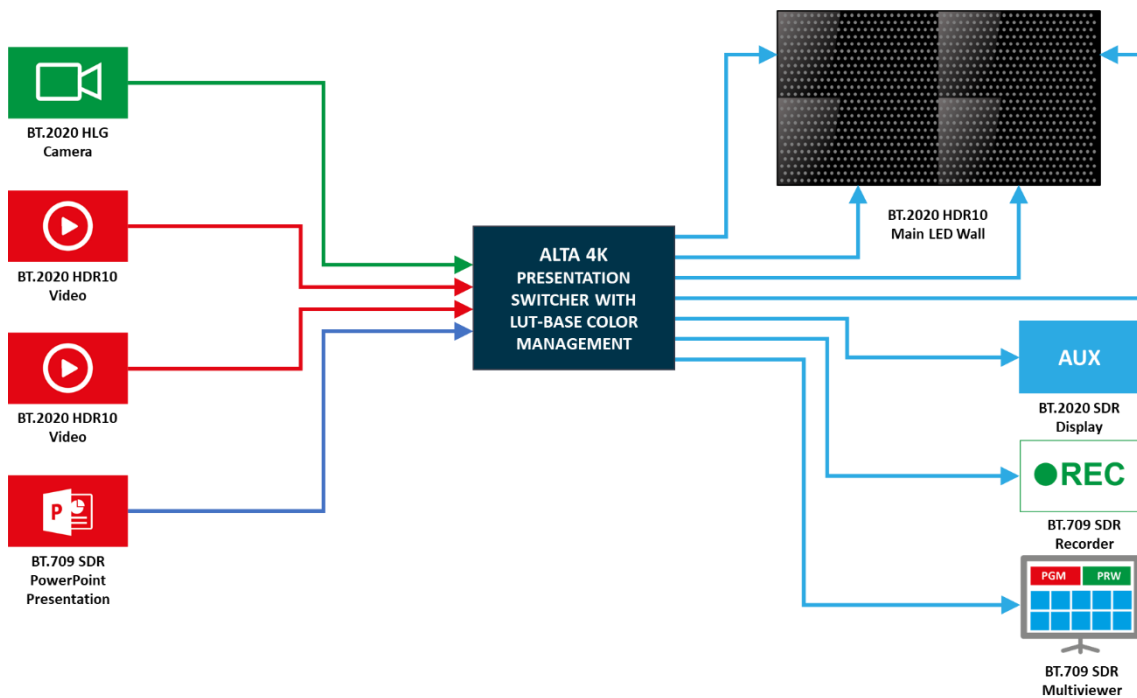

Figure 12: Example of heterogeneous workflow range setup with an Alta 4K system

4. Configuring the color processing

An Alta 4K system can be easily configured following these successive steps:

- Configuring the EDID of the inputs
- Configuring the internal processing
- Importing Custom LUTs
- Configuring the inputs
- Configuring the outputs

4.1. Configuring input EDIDs

For HDMI and DisplayPort inputs, configuring the EDID is crucial so that the source delivers its contents with the correct dynamic range.

To indicate the sink supports wide color gamut IUT-R BT.2020, its EDID must contain a CTA-861 extension including a Colorimetry Data Block with the BT2020RG and/or BT2020YCC enabled.

To indicate the sink supports HDR, its EDID must contain a CTA-861 extension including an HDR Static Metadata Data Block.

In Alta 4K series, there are two predefined EDIDs indicating the supported types of EOTF (Electro-Optical Transfer Function):

- Perceptual Quantizer (HDR10)
- Hybrid Log-Gamma

These EDIDs are in the *SETUP>EDID* page of the Web RCS. One is for HDMI inputs and the other one is for DisplayPort inputs.

Default EDIDs											
AW1	ALTA_4K_DP 3840x2160 60Hz Displayport 2160p60Hz	AW2	ALTA_4K_HDMI 3840x2160 60Hz HDMI 2.0 2160p60Hz	AW3	ALTA_4K_DP 3840x2160 59.99Hz Displayport 2160p60Hz RB	AW4	ALTA_4K_HDMI 3840x2160 59.99Hz HDMI 2.0 2160p60Hz RB	AW5	ALTA_4K_DP 1920x1080 60Hz Displayport 1080p60Hz	AW6	ALTA_4K_HDMI 1920x1080 60Hz HDMI 2.0 1080p60Hz
AW7	ALTA_4K_DP 3840x2160 50Hz Displayport 2160p50Hz	AW8	ALTA_4K_HDMI 3840x2160 50Hz HDMI 2.0 2160p50Hz	AW9	ALTA_4K_DP 3840x2160 50Hz Displayport 2160p50Hz RB	AW10	ALTA_4K_HDMI 3840x2160 50Hz HDMI 2.0 2160p50Hz RB	AW11	ALTA_4K_DP 1920x1080 50Hz Displayport 1080p50Hz	AW12	ALTA_4K_HDMI 1920x1080 50Hz HDMI 2.0 1080p50Hz
AW13	ALTA_4K_HDMI 1920x1080 60Hz HDMI 1.4 1080p60Hz	AW14	ALTA_4K_HDMI 1920x1080 50Hz HDMI 1.4 1080p50Hz	AW15	ALTA_4K_DP 1920x1080 120Hz Displayport 1080p120Hz	AW16	ALTA_4K_HDMI 1920x1080 120Hz HDMI 2.0 1080p120Hz	AW17	ALTA_4K_HDMI 1920x1080 120Hz HDMI 1.4 1080p120Hz	AW18	ALTA_4K_DP 1920x1080 240Hz Displayport 1080p240Hz
AW19	ALTA_4K_HDMI 1920x1080 240Hz HDMI 2.0 1080p240Hz	AW20	ALTA_4K 1920x1080 60Hz HDMI HDR 1080p60Hz	AW21	ALTA_4K_DP 1920x1080 60Hz Displayport HDR 1080p60Hz						

Figure 13: Default EDIDs for HDR support

When an HDMI or DisplayPort source reads such an EDID, it sends InfoFrames to the sink indicating that HDR is enabled, its type etc. Thanks to these InfoFrames, the Alta 4K can update its input status. This status is visible in the page *SETUP>Inputs>Input_xx* of the Web RCS.

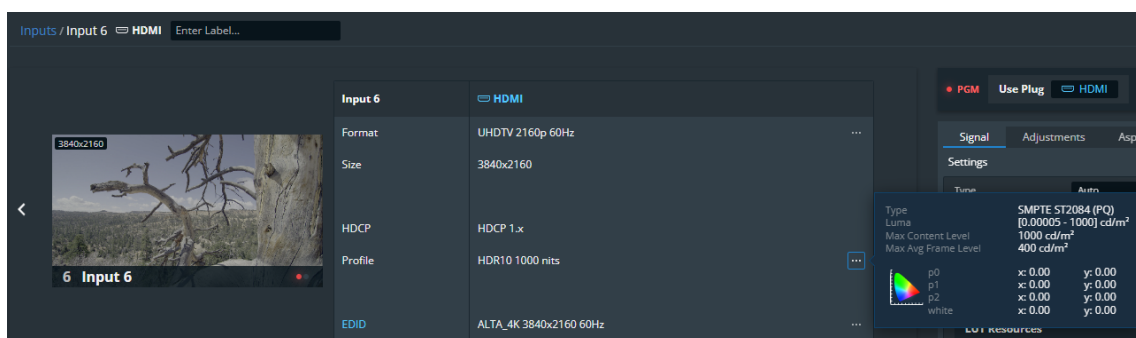

Figure 14: Status of Input 5 receiving an HDR10 1000nits content

IMPORTANT: If for any reasons, the sink does not receive InfoFrames from the source, it is still possible to force the dynamic range type. For further details, please refer to the Input configuration chapter 4.4.

4.2. Configuring the internal color processing

As previously said, all inputs must be converted to the same color space and dynamic range to be mixed properly.

These settings are available in the page *SETUP>Preconfig>System* of the Web RCS.

To configure the right Color Space type and Internal Profile, the main sources and displays must be identified. Then they should be set so the minimum number of conversions is necessary for them.

First select the type of the Color Space to use:

- YCbCr ITU-R BT.709. | For SDR setup
- YCbCr ITU-R BT.2020. | For Wide-gamut SDR or HDR

IMPORTANT: Note that the Alta 4K series uses Limited RGB only and not Full RGB. Reminder, at 8 bits per component Limited RGB uses a 16-235 range when Full RGB uses a 0-255 range.

Then select the Internal Profile:

- SDR
- HDR10
- HLG

IMPORTANT: If HDR10 is selected, a large amount of luminance values is available: the luminance must be selected to the nit level just above the max level of the main sources.

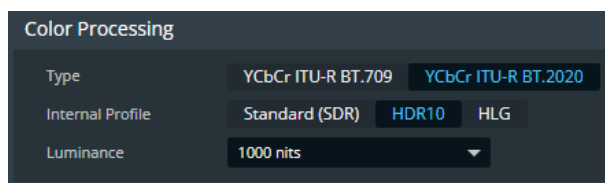

Figure 15: Example of a Color Processing configuration for HDR10

Tip: you can use the input status to get the maximum level of an input (page *SETUP>Inputs>Input_xx* of the Web RCS)

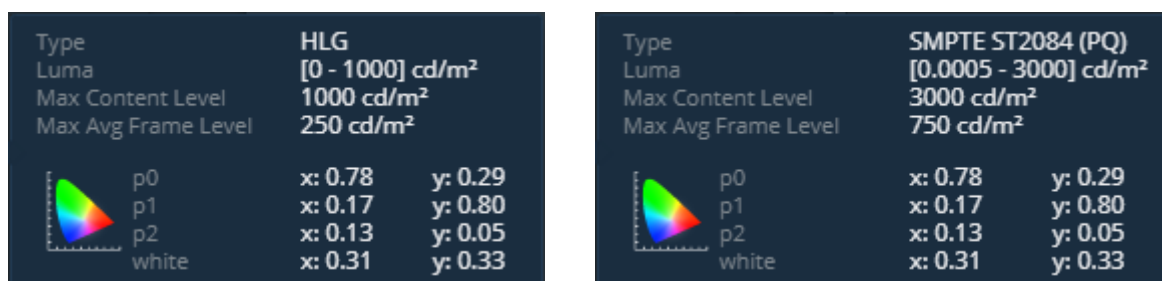

Figure 16: Example of source statuses

4.3. Importing custom LUTs

For advanced applications, it may be useful to import custom made LUTs into an Alta 4K. This can be achieved in the page *SETUP>LUT Libraries* of the Web RCS.

The Alta 4K series accepts CUBE files (".cube" extension) as defined by Adobe in "Cube LUT Specification Version 1.0". As this format doesn't include metadata about the input and output, additional information must be set before uploading the file to the Alta 4K.

These files can be dragged and drop to the selected slot or chosen via the selection window by clicking on "Update LUT File".

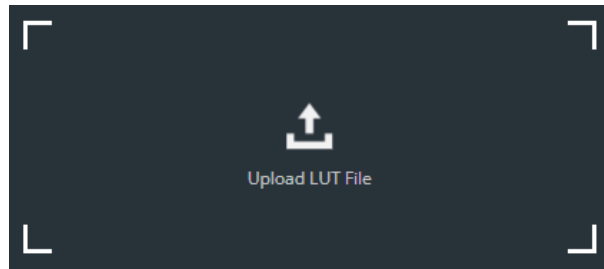

Figure 17: Hovering over an empty slot

4.3.1. Importing conversion LUTs

For Conversion LUTs, information about the input/output properties of the LUT must be set.

A dark-themed window titled "Conversion LUT". At the top, there is a file icon and the filename "SDR-2020-L_HLG-2020-L_BBC-ITM.cube". Below this is a form with several sections: "UPLOAD LUT" with a "Label" field containing "Enter Label..."; "CONVERT FROM" with "Color Space" set to "sRGB Limited (ITU-R BT.709)", "HDR Profile" with buttons for "Standard (SDR)", "HDR10", and "HLG", and "Luminance" set to "100 nits"; "CONVERT TO" with "Color Space" set to "RGB Limited (ITU-R BT.2020)", "HDR Profile" with buttons for "Standard (SDR)", "HDR10", and "HLG", and "Luminance" set to "1000 nits". At the bottom of the form is a large orange "Upload" button.

Figure 18: Upload form for a conversion LUT

Once the LUT is uploaded, it appears in the library with its properties. At the bottom right part of the slot, a small indicator shows if the LUT is currently being used.

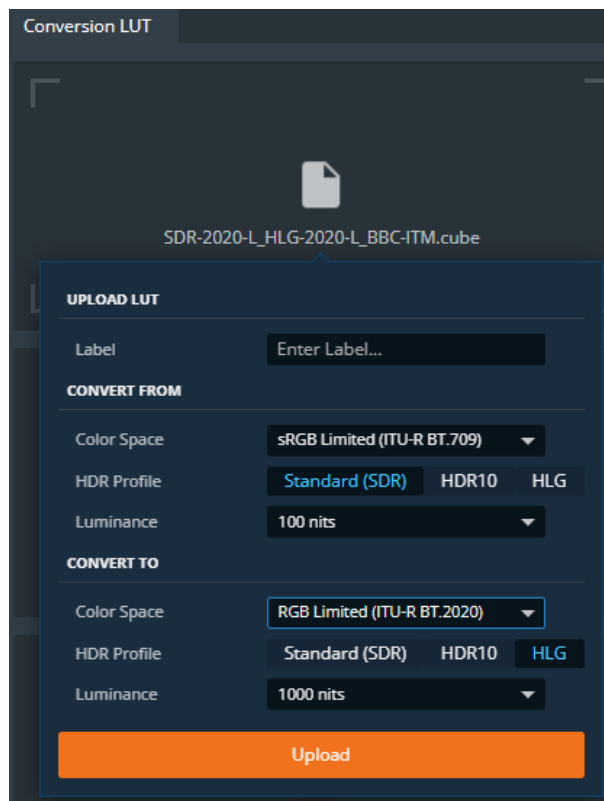
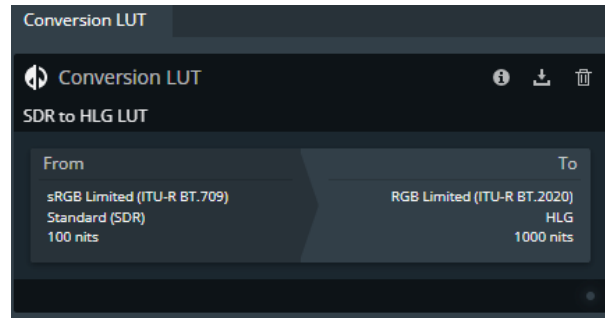

Figure 19: Slot of a conversion LUT after upload

4.3.2. Importing correction LUTs

For Correction LUTs, the color space used by the LUT must be set.

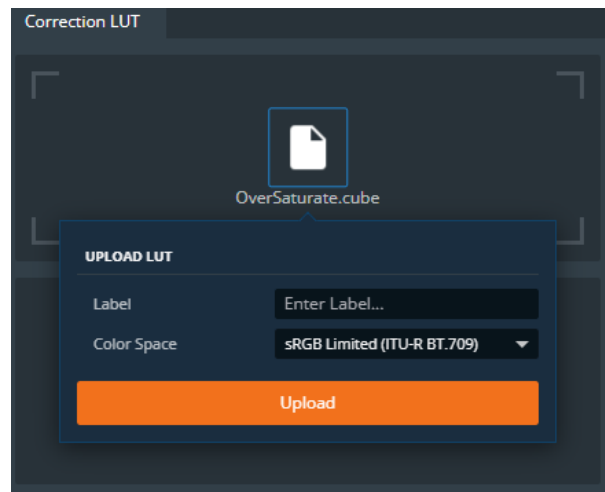

Figure 20: Upload form for a correction LUT

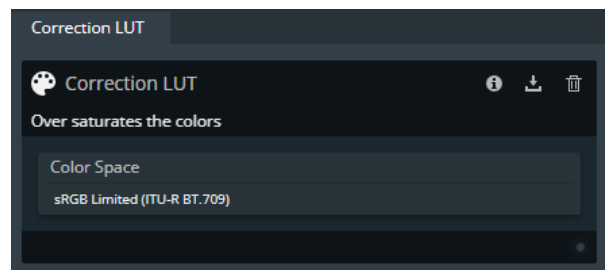

Figure 21: Slot of a correction LUT after upload

Once the LUT is uploaded, it appears in the library with its properties. At the bottom right part of the slot, a small indicator shows if the LUT is currently being used.

4.4. Configuring the conversions for inputs

The HDR settings of the inputs are available in the *Group Signal* tab of the Web RCS page *SETUP>Inputs>Input_xx*.

By default, all the settings are configured in AUTO mode. In this mode, all the input settings are automatically computed to create a consistent workflow in terms of color space and dynamic range. Embedded LUTs are used (some created by the BBC, some created by Analog Way).

However, it may happen that the InfoFrames are not sent properly by the source. Therefore, the input settings allow to override the status.

On Alta 4K series, only 4 LUT resource could be allocate to 4 different inputs, from input 1 to input 10, allowing them to change their dynamic range setting and to use custom Conversion Mode. The remaining inputs have their one resource allocated. Reminder, inputs 1 and 2 are limited to HDMI 1.4 (without HDR) and to 3G-SDI.

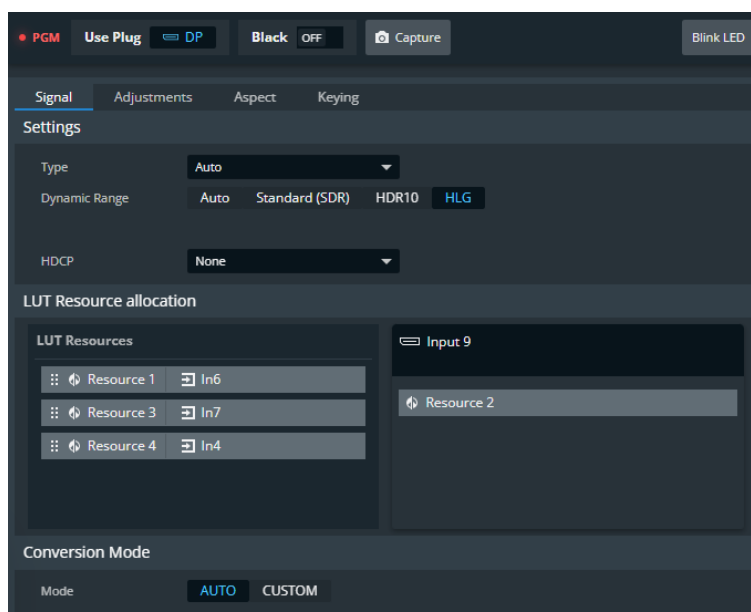

Figure 22: Forcing the dynamic range of an input

When selecting “LUT” in the section “Conversion Mode” of the tab, it is also possible to use a Custom LUT form the conversion LUT library instead of the predefined one.

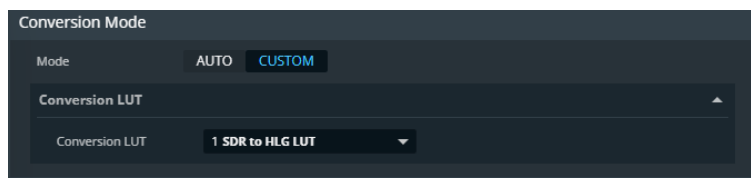

Figure 23: Selecting an input custom conversion LUT

IMPORTANT: For each input, the list of available LUTs is filtered depending on their compatibility with the input properties and the internal processing.

4.4.1. Configuring the inputs with an SDR internal processing

Input Profile	Settings
SDR	No settings as no conversion.
HDR10	<p>Luminance: to help the system to apply the most efficient LUT, the closest value above the input luminance level must be selected among:</p> <ul style="list-style-type: none"> - 100 nits - 700 nits - 1800 nits - 7000 nits - 200 nits - 800 nits - 2000 nits - 8000 nits - 300 nits - 1000 nits - 3000 nits - 9000 nits - 400 nits - 1200 nits - 4000 nits - 10000 nits - 500 nits - 1400 nits - 5000 nits - 600 nits - 1600 nits - 6000 nits
HLG BBC	<p>BBC Reference: depending on the content type, the conversion will also be different. Two types are available:</p> <ul style="list-style-type: none"> - Scene referred: Input is a camera or a graphic with camera image. - Display referred: Input is a graded content or graphics. <p>BBC OETF: if the reference type is Scene referred, two types of OETF are available, and this setting must be chosen according to the camera specifications between the two values:</p> <ul style="list-style-type: none"> - Square Root. - Strict (BT.709).

4.4.2. Configuring the inputs with an HDR10 internal processing

Input Profile	Settings
SDR	<p>Luminance: to help the system to apply the most efficient LUT so that the white level of the SDR content is not too bright leading to burned content, two values are available:</p> <ul style="list-style-type: none"> - 100 nits: standard luminance of SDR. - 200nits: ITU-R BT.2408-3 recommends around 58% of the PQ level, this corresponds to a 200nit luma level. <p>IMPORTANT: SDR→HDR10→SDR conversion may alter the colors</p>
HDR10	No settings: as PQ scale uses an absolute scale.
HLG BBC	No settings: luminance is automatically forced to 1000 nits.

4.4.3. Configuring the inputs with an HLG BBC internal processing

Input Profile	Settings
SDR	<p>BBC Mapping: when converting SDR to HLG, pixels must be converted from the BT.601 / BT.709 color spaces to BT.2020 color space. This operation can be configured either as:</p> <ul style="list-style-type: none"> - Inverse Tone Mapping: conversion output is extended to -5%/+105%. This setting must only be used when the input color space and the internal color space have a limited range. - Direct Mapping: each color of the input color space remains the same one. <p>BBC Reference: depending on the content type, two conversion types are available:</p> <ul style="list-style-type: none"> - Scene referred: Input is a camera or a graphic with camera image. - Display referred: Input is a graded content or graphics. <p>BBC OETF: if the reference type is Scene referred, two types of Opto-Electric Transfer Function are available, and this setting must be chosen according to the camera specifications between the two values:</p> <ul style="list-style-type: none"> - Square Root - Strict (BT.709)
HDR10	<p>Luminance: to help the system to apply the most efficient LUT, the closest value above the input luminance level must be selected among:</p> <ul style="list-style-type: none"> - 100 nits - 700 nits - 1800 nits - 7000 nits - 200 nits - 800 nits - 2000 nits - 8000 nits - 300 nits - 1000 nits - 3000 nits - 9000 nits - 400 nits - 1200 nits - 4000 nits - 10000 nits - 500 nits - 1400 nits - 5000 nits - 600 nits - 1600 nits - 6000 nits
HLG BBC	No settings as no conversion.

4.5. Configuring the color correction LUT for inputs

The color correction settings of the inputs are available in the *Group Adjustments* tab of the Web RCS page *SETUP>Inputs>Input_xx*.

The LUT mode must be selected and the LUT must be chosen in the dropdown list.

IMPORTANT: For each input, the list of available LUTs is filtered depending on their compatibility with the input properties.

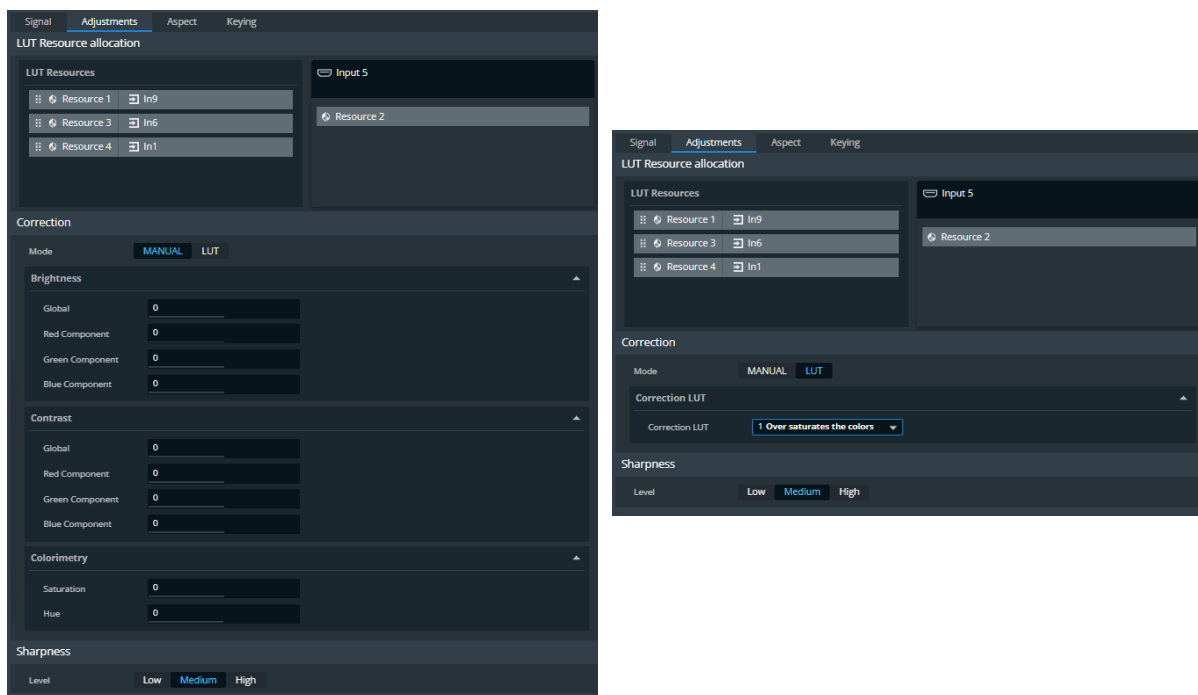

Figure 24: Standard manual color correction (left) vs LUT-based color correction (right)

IMPORTANT: Please note that both modes are exclusive and cannot be cumulated.

4.6. Configuring the conversions for outputs

The HDR settings of the outputs are available in the *Signal* tab of the Web RCS page *SETUP>Outputs>Output_xx*.

By default, all the settings are configured in AUTO mode. In this mode, all the output settings are automatically computed using the EDID status of the output device and the internal profile. Embedded LUTs are used (some created by the BBC, some created by Analog Way). However, it is possible to force the configuration of an output using its settings.

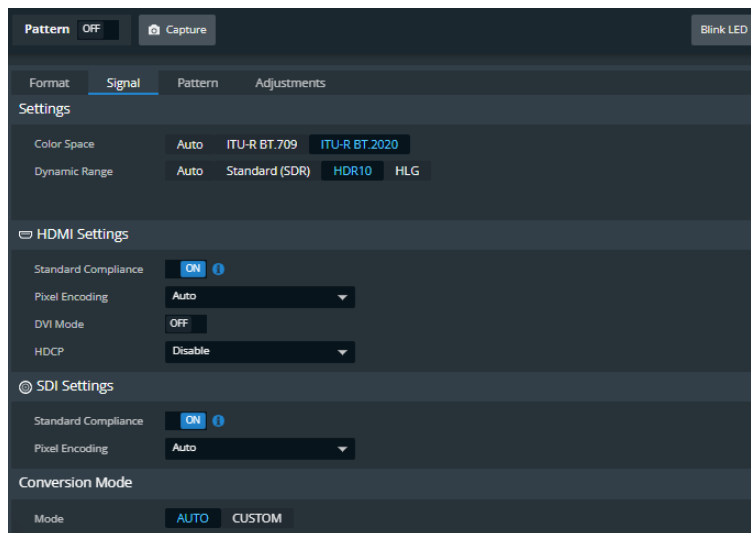

Figure 25: Forcing the color space and dynamic range of an output

When selecting “LUT” in the section “Conversion Mode” of the tab, it is also possible to use a Custom LUT from the conversion LUT library instead of the predefined one.

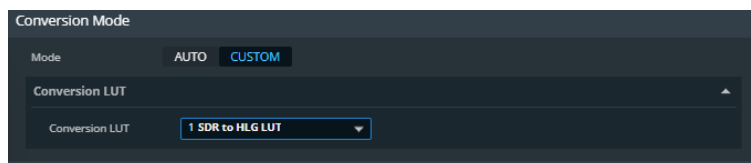

Figure 26: Selecting an output custom conversion LUT

IMPORTANT: For each output, the list of available LUTs is filtered depending on their compatibility with the output settings and the internal processing.

4.6.1. Configuring the outputs with an SDR internal processing

Output Profile	Settings
SDR	No settings as no conversion.
HDR10	<p>Luminance: to help the system to apply the most efficient LUT and send the proper InfoFrame, two values are available:</p> <ul style="list-style-type: none"> - 100 nits: standard luminance of SDR. - 200nits: ITU-R BT.2408-3 recommends around 58% of the PQ level, this corresponds to a 200nit luma level.
HLG BBC	<p>BBC Mapping: when converting SDR to HLG, pixels must be converted from the BT.601 and BT.709 color spaces to BT.2020 color space. This operation can be configured either as:</p> <ul style="list-style-type: none"> - Inverse Tone Mapping: the output of the conversion is extended to -5%/+105%. This setting must only be used when the output color space and the internal color space have a limited range. - Direct Mapping: each color of the output color space stays the same one. <p>BBC Reference: depending on the content type, the conversion will also be different. Two types are available:</p> <ul style="list-style-type: none"> - Scene referred: Input is a camera or a graphic with camera image. - Display referred: Input is a graded content or graphics. <p>BBC OETF: this setting is only available if the reference type is Scene referred. Two types of OETF are available, and this setting must be chosen according to the camera specifications between two values:</p> <ul style="list-style-type: none"> - Square Root. - Strict (BT.709) (recommended).

4.6.1. Configuring the outputs with an HDR10 internal processing

Output Profile	Settings
SDR	No settings: the system automatically selects the best LUT according to the internal processing nit level.
HDR10	No settings: as PQ uses an absolute scale. The output sends a Luminance InfoFrame based on the Internal Profile Luminance.
HLG BBC	No settings: the system automatically selects the best LUT according to the internal processing nit level.

4.6.2. Configuring the outputs with an HLG BBC internal processing

Output Profile	Settings
SDR	<p>BBC Reference: depending on the content type, the conversion will also be different. Two types are available:</p> <ul style="list-style-type: none"> - Scene referred: Input is a camera or a graphic with camera image. - Display referred: Input is a graded content or graphics. <p>BBC OETF: if the reference type is Scene referred. Two types of OETF are available, and this setting must be chosen according to the camera specifications between the two values:</p> <ul style="list-style-type: none"> - Square Root - Strict (BT.709)
HDR10	No settings: the Luminance InfoFrame is automatically forced to 1000 nits.
HLG BBC	No settings as no conversion.

4.7. Configuring the color correction LUT for outputs

The color correction settings of the outputs are available in the *Adjustments* tab of the Web RCS page *SETUP>Outputs>Output_xx*.

The LUT mode must be selected and the LUT must be chosen in the dropdown list.

IMPORTANT: the list of available LUTs is filtered depending on their compatibility with the output properties.

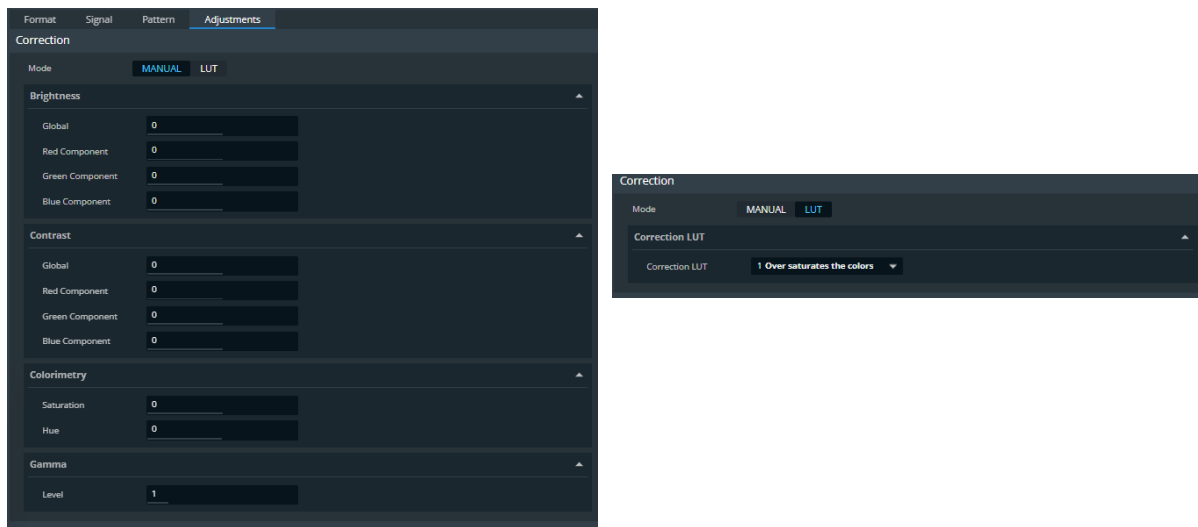

Figure 27: Standard manual color correction (left) vs LUT-based color correction (right)

IMPORTANT: Please note that both correction modes are exclusive and cannot be cumulated.