

USER MANUAL

LivePremier™ unit (v2.5)

References:

AQL-RS-ALPHA, AQL-RS1, AQL-RS2,
AQL-RS3, AQL-RS4, AQL-C, AQL-C+



ANALOG WAY®
Pioneer in Analog, Leader in Digital

Information contained in this document, in particular data, pictures, information, trademarks and logos are exclusive property of Analog Way and are protected by copyrights and other intellectual property rights.

2019, Analog Way, all rights reserved – 04/2022

Consequently, any representation and/or reproduction, in part or in full, is prohibited and would be considered a violation of Analog Way's copyright and other intellectual property rights.

Visual representations (diagrams, photos, icons, pictograms, screenshots, spare parts, etc.) are not contractual.

Contents

1	Disclaimer	10
1.1	Copyrights	10
1.2	Warranty	10
1.3	Liability	10
1.4	Force Majeure	10
2	Terms and Definition	11
3	Hardware Specifications	12
3.1	Safety instructions	12
3.1.1	English.....	12
3.1.2	French.....	13
3.1.3	Italian.....	14
3.1.4	German.....	15
3.1.5	Spanish	16
3.1.6	Environmental specifications for all LivePremier models.....	17
3.1.7	UPS compatibility	17
3.2	Package Contents.....	17
3.3	Rack mount information	17
4	Introducing LivePremier™	18
4.1	LivePremier – Modular architecture.....	18
4.2	Supported formats and rates	18
4.3	Front panel.....	19
4.4	LivePremier rear panels	19
4.5	Input / Output cards	20
4.5.1	Available cards.....	20
4.5.2	Change an input / output card	20
4.6	Fixed parts.....	21
4.6.1	Optional control card with DisplayPort Multiviewer outputs	21
4.6.2	USB and sync ports	21
4.6.3	Framelock	21
4.6.4	GPIO.....	21
4.6.5	Dante audio connectors	22
4.6.6	Power supply units	22
4.6.7	LivePremier accessories.....	23
4.7	Power on and off.....	24
4.7.1	Start the LivePremier	24
4.7.2	Power off	24
4.7.3	Forced shutdown	24
4.8	Precautions when mounting a LivePremier unit	24
5	Using the Web RCS	25
5.1	Run the Web RCS	25
5.1.1	Web RCS requirements.....	25
5.1.2	Default network settings	26
5.1.3	Connection	26

5.1.4	Login page.....	26
5.1.5	LivePremier Simulator	26
5.2	General tips.....	27
5.2.1	Web browser features.....	27
5.2.2	Mobile version.....	27
5.2.3	Section buttons (copy, paste and reset).....	27
5.2.4	Set a number value.....	27
5.2.5	Search bar.....	28
5.2.6	Alarms and notifications.....	28
5.3	Device control synchronization.....	28
5.3.1	Web RCS synchronization.....	28
5.3.2	RC400T synchronization	29
5.3.3	Back panel shortcuts.....	29
5.3.4	Standby / Restart.....	29
5.4	Dashboard - System settings.....	30
5.4.1	Dashboard – Device.....	30
5.4.2	Dashboard – Network.....	31
5.4.3	Dashboard – Remote Access	31
5.4.4	Dashboard – Remote Control	32
5.4.5	Dashboard – Firmware / Hardware (Firmware Update)	33
5.4.6	Dashboard – Power	34
5.4.7	Dashboard – Cooling.....	34
5.5	Save / Load Configuration.....	34
5.5.1	Save the current Configuration in a Slot.....	35
5.5.2	Load a Configuration from a Slot.....	35
5.5.3	Export a Configuration to the computer	36
5.5.4	Import a Configuration	36
5.6	Reset configuration.....	36
6	LivePremier concepts.....	37
6.1	What is “Capacity”?	37
6.1.1	Standard formats capacity.....	37
6.1.2	Elements using capacity	37
6.1.3	Content and layer compatibility	38
6.2	Screen layers	39
6.2.1	Screen sources.....	39
6.2.2	Mixing layers.....	39
6.2.3	Split layers	39
6.3	Aux Screens and Aux layers	40
6.3.1	Aux layers quantity and capacity.....	40
6.3.2	Aux layers limitations	40
6.4	LivePremier Processing	41
6.4.1	VPUs and Scaling engines	41
6.4.2	Self-rearrangement	42
6.4.3	A VPU can support both capacities at the same time	43
6.4.4	Scaling engine boundary.....	43
6.4.5	Combined VPUs	44

6.4.6	Optimized mode	44
6.4.7	Cut & Fill resources	45
6.4.8	How many VPUs per model?	45
6.4.9	IPUs	45
6.5	HDR conversion	46
6.6	LivePremier latency	46
7	Preconfig Menu	47
7.1	Preconfig > System	47
7.1.1	Vertical rate	47
7.1.2	Framelock input settings	48
7.1.3	Framelock output settings	48
7.1.4	Color processing	48
7.1.5	Quick HDCP	49
7.2	Preconfig > Multiviewers	49
7.2.1	Multiviewers quantity	49
7.2.2	Set a DPH104 for a Multiviewer DP output	49
7.3	Preconfig > Screens / Aux Screens	50
7.3.1	Output group	51
7.3.2	Output capacity – The 4-4 rule	51
7.3.3	Set an output group for a Screen	52
7.3.4	Set a DPH104 output for a Screen	52
7.3.5	Set an output for an Aux Screen	52
7.3.6	Aux output duplication	53
7.3.7	Create a Screen	54
7.3.8	Create an Aux Screen	54
7.3.9	Rename a Screen	54
7.4	Preconfig > Canvas	55
7.4.1	Tree view	56
7.4.2	Set output rotation	56
7.4.3	Patterns	58
7.4.4	Grid canvas	59
7.4.5	Free canvas	60
7.4.6	Advanced output settings (in Preconfig > Canvas)	62
7.5	Preconfig > Inputs	63
7.5.1	Input group	63
7.5.2	Set an input group	63
7.5.3	Set four 3G-SDI inputs for 2SI format	63
7.6	Preconfig > Images	64
7.6.1	Image slots	64
7.6.2	Set images preset capacity	64
7.7	Preconfig > Backgrounds	65
7.7.1	Background sets	65
7.7.2	Background set for a Screen with one output group	65
7.7.3	Background set for a Screen with multiple output groups	65
7.7.4	Reset a background set	65
7.7.5	Remove a source from all background sets	65

8	Multiviewers	66
8.1	Multiviewers settings.....	66
8.2	Multiviewer format.....	66
8.3	Multiviewers pattern	66
8.4	Multiviewers signal	67
8.5	Multiviewers adjustment (image correction)	67
9	Outputs	68
9.1	Outputs main screen.....	68
9.2	Output settings	68
9.2.1	Output group format.....	69
9.2.2	Output group pattern	69
9.2.3	Output signal	70
9.2.4	Output adjustment (image correction)	71
10	Inputs	72
10.1	Inputs main screen.....	72
10.2	Input settings	72
10.2.1	Input group signal.....	73
10.2.2	Input group pattern.....	73
10.2.3	Input group adjustment (image correction)	74
10.2.4	Input group aspect	74
10.2.5	Input Keying.....	75
11	Images and Library	76
11.1	Library	76
11.1.1	Image formats	76
11.1.2	Image specifications	76
11.1.3	Transfer images from the computer to the unit.....	77
11.1.4	Capture a video signal into an image file.....	77
11.1.5	Download an image file from the unit.....	77
11.1.6	Delete an image file from the unit	77
11.1.7	Manage Library from the Front panel	78
11.2	Images.....	78
11.2.1	Images main screen	78
11.2.2	Image slots settings	78
11.2.3	Downscale to capacity	78
11.2.4	Assign an imported image to an image slot	79
11.2.5	Assign a timer to an image slot	79
11.2.6	Image signal.....	79
11.2.7	Image aspect.....	80
12	Formats and EDID	81
12.1	Formats	81
12.1.1	Create a custom format.....	81
12.1.2	Edit a custom format	81
12.1.3	Delete a custom format.....	81
12.2	EDID.....	82
12.2.1	EDID bank	82

12.2.2	Save an EDID from inputs and outputs.....	82
12.2.3	Replace an Input EDID with an EDID from the bank.....	82
12.2.4	Set a template format for an EDID	82
12.2.5	Set a custom format for an EDID	83
12.2.6	Export an EDID to computer.....	83
12.2.7	Import an EDID from computer	83
12.2.8	Delete a custom EDID	83
13	Audio and Extras	84
13.1	Audio	84
13.1.1	Reboot or reset the Dante audio card.....	84
13.1.2	Audio routing.....	84
13.1.3	Default audio routing	85
13.1.4	Advanced audio routing (single channel)	85
13.2	Timers.....	86
13.2.1	Create a timer	86
13.2.2	Control counter timers in Live menus	86
13.2.3	Use timers in Screens and Aux. Screens	87
13.3	GPIO	87
13.3.1	Pins table and GPIO connection	87
13.3.2	On/Off switch pins.....	88
13.3.3	Set GPIO in the Web RCS	89
14	Screens / Aux.	90
14.1	Screens menu interface	90
14.1.1	Program and Preview	90
14.1.2	Views	90
14.1.3	Sources - Left panel	92
14.1.4	Layer selection.....	92
14.1.5	Screen layout editor	93
14.1.6	PGM and PRW buttons – Screen controls	93
14.1.7	Bottom bar buttons	94
14.1.8	Transitions - Right panel.....	95
14.2	Layer properties	95
14.2.1	Layer selection and tools.....	96
14.2.2	Layer position and size	96
14.2.3	Layer source.....	97
14.2.4	Cut & Fill effect	98
14.2.5	Set layer opacity	99
14.2.6	Set layer crop and aspect	99
14.2.7	Set layer mask.....	99
14.2.8	Set layer border	99
14.2.9	Set layer smooth border.....	100
14.2.10	Set layer shadow	100
14.2.11	Set layer color filter	100
14.2.12	Set layer Horizontal and Vertical flip	100
14.3	Layer transition	101
14.3.1	Set layer transition effect	101

14.3.2	Set layer transition timing	101
14.3.3	Set layer transition speed	101
14.4	Aux Screens	102
14.4.1	Aux layers limitations	102
15	Memories	103
15.1	Memories tab	103
15.2	Master Memories	104
15.2.1	Save a Master memory from current Screens	104
15.2.2	Save a Master memory from existing Screen memories	105
15.2.3	Load a Master memory	105
15.2.4	Load a Master memory at startup	105
15.2.5	Edit a Master memory	106
15.3	Screen Memories	106
15.3.1	Save a Screen memory	106
15.3.2	Load a Screen memory	107
15.3.3	Edit a Screen memory	107
15.3.4	Quick overwrite or revert	107
15.4	Layer Memories	108
15.4.1	Save a Layer memory	108
15.4.2	Load a Layer memory	108
15.4.3	Edit a Layer memory	108
15.5	Rename a Memory	109
15.6	Change the color of a Memory slot	109
15.7	Reorder memories	109
15.8	Delete a memory	109
16	Multiviewers	110
16.1	Tips and recommendations	110
16.2	Multiviewers menu interface	110
16.2.1	Sources - Left panel	111
16.2.2	Widget selection	112
16.2.3	Multiviewer layout editor	113
16.2.4	Bottom bar buttons	113
16.3	Widget properties	114
16.3.1	Widget position and size	114
16.3.2	Widget source - Assign content to a widget	115
16.4	Multiviewers memories	115
16.4.1	Save a Multiviewer memory	115
16.4.2	Load a Multiviewer memory	115
16.4.3	Load a Multiviewer memory at startup	115
16.4.4	Edit a Multiviewer memory	116
16.4.5	Rename a Memory	116
16.4.6	Change the color of a Memory slot	116
16.4.7	Reorder memories	116

17	User Maintenance and Troubleshooting.....	117
17.1	User Maintenance – Air filter.....	117
17.2	Troubleshooting.....	117
APPENDICES	118
Appendix A. RC400T	118
Appendix B. Other LivePremier control options	127
CONTACT INFORMATION	128

1 Disclaimer

The information in this document is subject to change without notice, while every effort is made to be accurate. Analog Way cannot be held liable for any kind of loss whatsoever that may be caused by the use of or reliance in this manual.

1.1 Copyrights

The software installed in the LivePremier remains the sole property of Analog Way unless stated otherwise in a separate licensing agreement. Any attempt to copy or alter the software is prohibited and will render any warranties void.

1.2 Warranty

The LivePremier has been tested in various applications and is deemed to be suitable for uses described in this manual. This product is provided “as is”, including all or any ‘perceived’ or possible faults. The Licensor grants no warranty regarding the utility or contents of the software. Analog Way will warrant the hardware for three years from the date of purchase on parts and labor, excluding I/O connector cards which are warranted for one year. Broken connectors are not covered by warranty. The method of warranty is Return to Base (transport costs from and to us are the owner’s responsibility). In case of hardware fault please contact your local distributor or us (www.analogway.com).

While not an exhaustive list, the following are provided for guidance. Warranty claims will be invalidated in these circumstances:

- A hardware failure is caused by inappropriate handling of hardware such as dropping the image processor, using the image processor without proper ventilation, exposing the unit to water, other liquids or dust.
- The software has been loaded or there has been an attempt to load software onto the unit in any way other than described in the manual or recommended by Analog Way.
- The hardware has been modified by someone other than a certified Analog Way dealer.

1.3 Liability

Analog Way shall not be liable for any loss or damage, be it direct or indirect in regards to the utility or contents of the software or hardware, except to the extent provided by law. Notwithstanding the above, liability for indirect, special, incidental or consequential loss or damage that may arise in respect of the software or hardware, is expressly excluded.

1.4 Force Majeure

Liability of Analog Way is excluded in all cases that constitute Force Majeure circumstances, namely, circumstances beyond the control of Analog Way.

2 Terms and Definition

Auxiliary Screen or Aux: A specific Screen composed of a single output with a format up to 4K@60. Aux Screens consume zero processing resources. The content displayed can be an input, an image or a Screen's Program. An Aux can display 2, 4, 6 or 8 layers.

Background: Input or Image source displayed behind all other layers. The background consumes zero processing resources and can display unscaled content on the whole screen.

Capacity: Unit used in the Web RCS to ensure inter-operability between all the internal elements of a LivePremier unit. One level of capacity refers to Dual-Link bandwidth 2560x1600@60.

Cut & Fill: Feature that allows a layer to be displayed with perfect keying to give it a specific shape. One content is used to cut another content in the same layer (via Luma keying).

Hard edge: Technology used to display continuous content using multiple outputs without any covering area. The outputs are "side by side", they do not overlap or share pixel information. (Opposed to **Soft Edge** where some parts of the image are overlapping while projected on multiple displays.)

Image: Encompasses all non-animated images. Images are imported through the Web RCS and used as content in layers.

Keying: Electronic process where a video image is electronically superimposed over another source by dynamically removing a portion of the first image. For example, removing all content of a certain color (such as green or blue) is called **Chroma Key** and removing content based on its luminance levels is called **Luma Key**. Keying is typically used for titles, logos and special effects.

Layer: Item displaying one content (Live inputs, Image or Screen Program). Layers can overlap, depending on their visual priority. Layers can be repositioned, resized, displayed with borders, etc.

Multiviewer: Dedicated output used to monitor content in widgets. LivePremier units have two 4K Multiviewer outputs, each one able to display up to 64 widgets.

Picture in Picture (PIP): Often used as a synonym to layer. Displaying a content over another content.

Preview (PRW): The content in Preview is not displayed on output Screens. All Preview screens replace their corresponding Program screens during transition (or Take). Preview Screens are meant to load layers and content before transitioning to Program.

Program (PGM): The content in Program shows what is currently displayed on Screens. It is possible to make changes directly in the Program screens (drag and drop content in layers, layer size and position, etc.). It is also possible to lock the Program screens to only edit the Preview screens.

Screen: Destination where the picture will be displayed. For example, a single display or a projection surface which can be composed of one or multiple outputs. Each screen is composed with of one or multiple layers.

Soft edge blending: Technology used to compensate for the covering area when two (or more) video projectors are combined to display a continuous content across one screen. The resulting image will appear as a single unified picture.

Web RCS: User interface to setup and operate the LivePremier. It is a web browser based Remote Control Software designed by Analog Way.

Widget: Multiviewer item displaying one content (Input, Image, Timer, Preview or Program Screen). Similar to a Layer but without visual priority, widgets are displayed on same level and cannot overlap.

3 Hardware Specifications

3.1 Safety instructions

3.1.1 English

All of the safety and operating instructions should be read before the product is operated and should be maintained for further reference. Please follow all of the warnings on this product and its operating instructions.

- **WARNING:** To prevent the risk of electric shock and fire, do not expose this device to rain, humidity or intense heat sources (such as heaters and direct sunlight). This equipment is not suitable for use in locations where children are likely to be present.
- **INSTALLATION:** Slots and openings in the device are provided for ventilation and to avoid overheating. Make sure the device is never placed near a textile surface that could block the openings. Also keep away from excessive dust, vibrations and shocks.
- **POWER:** Connect earth before connecting to supply. Use an earth cable to earth a screw of the unit's chassis. Only use the power supply indicated on the device of the power source. Devices equipped with a grounding plug should only be used with a grounding type outlet. In no way should this grounding be modified, avoided or suppressed. Connection of equipment to main supply must be after branch circuit breaker of the building installation.
- **POWER CORD:** The device can be equipped with 2 or 3 detachable power cords, to remove mains, disconnect them at appliance coupler.

Caution: The power cords constitute the only mean to completely disconnect the equipment from the main power.

Use the following guidelines:

- The equipment connected to the network must have a release system easily accessible and located outside the unit.
- Unplug the power cords; do not pull on the power cords but always on the plug itself.
- The outlet should always be near the device and easily accessible.
- Power supply cords should be routed so that they are not likely to be walked on or pinched by items placed upon or against them.

If one of the power supply cords is damaged, unplug the device. Using the device with a damaged power supply cord may expose your device to electric shocks or other hazards. Verify the condition of the power supply cords periodically. Contact your dealer or service center for replacement if damaged.

- **CONNECTIONS:** All inputs and outputs (except for the power input) are Electrical energy source class 1 (ES1) as defined in IEC/UL 62368-1 edition 2.

ES1 limits: 60Vdc or 30V rms/ 42.4V peak.

- **SERVICING:** Disconnect all power supply cords from main before servicing.

According to IEC 62368-1 standard, an ordinary person is authorized to:

- Open the front panel cabinet and clean the air filter
- Change a removable power supply

Do not attempt to service this product yourself by opening or removing covers and screws since it may expose your device to electric shocks or other hazards. The internal Lithium cell battery is not replaceable. In case of problem, contact your supplier or Analog Way.

- **OPENINGS:** Never push objects of any kind into this product through the openings. If liquids have been spilled or objects have fallen into the device, unplug it immediately and have it checked by a qualified technician.

3.1.2 French

Afin de mieux comprendre le fonctionnement de cet appareil nous vous conseillons de bien lire toutes les consignes de sécurité et de fonctionnement avant utilisation. Conservez les instructions de sécurité et de fonctionnement afin de pouvoir les consulter ultérieurement. Respectez toutes les consignes marquées dans la documentation, sur le produit et sur ce document.

- **ATTENTION** : Afin de prévenir tout risque de choc électrique et d'incendie, ne pas exposer cet appareil à la pluie, à l'humidité ou à des sources de chaleur intense. Cet équipement ne convient pas pour une utilisation dans des endroits où des enfants sont susceptibles d'être présents.
- **INSTALLATION** : Mise à la terre obligatoire avant branchement. Utiliser un câble de terre pour relier une vis du châssis de l'appareil à la terre. Veillez à assurer une circulation d'air suffisante pour éviter toute surchauffe à l'intérieur de l'appareil. Ne placez pas l'appareil sur ou à proximité d'une surface textile susceptible d'obstruer les orifices de ventilation. N'installez pas l'appareil à proximité de sources de chaleur comme un radiateur ou une poche d'air chaud, ni dans un endroit exposé au rayonnement solaire direct, à des poussières excessives, à des vibrations ou à des chocs mécaniques. Ceci pourrait provoquer un mauvais fonctionnement et un accident.
- **ALIMENTATION** : Ne faire fonctionner l'appareil qu'avec la source d'alimentation indiquée sur l'appareil. Les appareils doivent être obligatoirement connectés sur une source équipée d'une mise à la terre efficace. En aucun cas cette liaison de terre ne devra être modifiée, contournée ou supprimée. Raccordement des équipements à l'alimentation principale doit être postérieur au disjoncteur de branchement de l'installation électrique du bâtiment.
- **CORDONS D'ALIMENTATION** : Les appareils peuvent être équipés de 2 ou 3 cordons d'alimentation détachables, la mise hors tension se fait en débranchant ces cordons de l'appareil.

Attention : Les cordons d'alimentation constituent le seul moyen de débrancher l'appareil totalement de l'alimentation secteur. Déconnecter tous les cordons d'alimentation.

Appliquer les consignes suivantes :

- Le matériel relié à demeure au réseau, doit avoir un dispositif de sectionnement facilement accessible qui doit être incorporé à l'extérieur de l'appareil.
- Débrancher les cordons d'alimentation de la prise murale si vous prévoyez de ne pas utiliser l'appareil pendant quelques jours ou plus.
- Pour débrancher les cordons, tirez-les par la fiche. Ne tirez jamais sur les cordons proprement dit.
- Les prises d'alimentation doivent se trouver à proximité de l'appareil et être aisément accessibles.
- Ne laissez pas tomber les cordons d'alimentation et ne posez pas d'objets lourds dessus.

Si un des cordons d'alimentation est endommagé, débranchez-le immédiatement de la prise murale. Il est dangereux de faire fonctionner un appareil avec un cordon endommagé ; un câble abîmé peut provoquer un risque d'incendie ou un choc électrique. Vérifiez les câbles d'alimentation de temps en temps. Contactez votre revendeur ou le service après-vente pour un remplacement.

- **CONNEXIONS** : Toutes les entrées et sorties (exceptée l'entrée d'alimentation) sont des sources d'énergie électrique de classe 1 (ES1) tel que défini dans IEC/UL 62368-1 édition 2.

ES1 : Electrical energy source class 1 (limites : 60Vdc ou 30V rms/ 42.4V peak).

- **RÉPARATION ET MAINTENANCE** : Débrancher les cordons d'alimentation avant toute maintenance.

Selon la norme IEC 62368-1, une personne ordinaire est autorisée à :

- Ouvrir la face avant pour nettoyer le filtre à air
- Changer un bloc d'alimentation

L'utilisateur ne doit en aucun cas essayer de procéder aux opérations de dépannage, car l'ouverture des appareils par retrait des capots ou de toutes autres pièces constituant les boîtiers ainsi que le dévissage des vis apparentes à l'extérieur, risquent d'exposer l'utilisateur à des chocs électriques ou autres dangers.

La pile bouton au Lithium présente à l'intérieur de la machine n'est pas remplaçable. En cas de problème, contactez le service après-vente, votre revendeur ou adressez-vous à un personnel qualifié uniquement.

• **OUVERTURES ET ORIFICES** : Les appareils peuvent comporter des ouvertures (aération, fentes, etc.), veuillez ne jamais y introduire d'objets et ne jamais obstruer ses ouvertures.

Si un liquide ou un objet pénètre à l'intérieur de l'appareil, débranchez immédiatement l'appareil et faites-le contrôler par un personnel qualifié avant de le remettre en service.

3.1.3 Italian

Allo scopo di capire meglio il funzionamento di questa apparecchiatura vi consigliamo di leggere bene tutti i consigli di sicurezza e di funzionamento prima dell'utilizzo. Conservare le istruzioni di sicurezza e di funzionamento al fine di poterle consultare ulteriormente. Seguire tutti i consigli indicati su questo manuale e sull'apparecchiatura.

• **ATTENZIONE**: Questo apparecchio non è adatto all'utilizzo da parte di bambini. Al fine di prevenire qualsiasi rischio di shock elettrico e d'incendio, non esporre l'apparecchiatura a pioggia, umidità e a sorgenti di eccessivo calore.

• **INSTALLAZIONE**: Assicuratevi che vi sia una sufficiente circolazione d'aria per evitare qualsiasi surriscaldamento all'interno dell'apparecchiatura. Non collocare l'apparecchiatura in prossimità o su superfici tessili suscettibili di ostruire il funzionamento della ventilazione. Non installate l'apparecchiatura in prossimità di sorgenti di calore come un radiatore o una fuoruscita d'aria calda, né in un posto esposto direttamente ai raggi del sole, a polvere eccessiva, a vibrazioni o a shock meccanici. Ciò potrebbe provocare un erroneo funzionamento e un incidente.

• **ALIMENTAZIONE**: Collegare la terra prima di collegarla all'alimentazione. Utilizzare un cavo di terra per mettere a terra la vite del telaio dell'unità. Far funzionare l'apparecchiatura solo con la sorgente d'alimentazione indicata sull'apparecchiatura. Le apparecchiature queste devono essere obbligatoriamente collegate su una sorgente fornita di una efficiente messa a terra. In nessun caso questo collegamento potrà essere modificato, sostituito o eliminato. Connessione delle apparecchiature alla rete elettrica deve essere successiva interruttore di circuito dell'impianto dell'edificio.

• **CAVI DI ALIMENTAZIONE**: Il dispositivo è dotato di due o tre cavi di alimentazione removibile, per rimuovere le alimentazioni scollegare i cavi dalla Presa.

Attenzione: i cavi di alimentazione sono l'unico di disconnettere l'apparecchio all'alimentazione.

Seguire le istruzioni seguenti:

- Il materiale collegato a residenza alla rete, deve avere un dispositivo di sezionamento facile da raggiungere e che deve essere inserito all'esterno del apparecchio.

- Scollegare l'apparecchiatura dalla presa a muro se si prevede di non utilizzarla per qualche giorno.

- Per disconnettere il cavo, tirare facendo forza sul connettore.

- La prese d'alimentazione deve trovarsi a prossimità dell'apparecchiatura ed essere facilmente accessibile.

- Non far cadere il cavo di alimentazione né appoggiarci sopra degli oggetti pesanti. Se il cavo di alimentazione è danneggiato, spegnere immediatamente l'apparecchiatura.

È pericoloso far funzionare questa apparecchiatura con cavi di alimentazione danneggiati, cavi graffiati possono provocare un rischio di incendio o uno shock elettrico. Verificare spesso i cavi di alimentazione. Contattare il vostro rivenditore o il servizio assistenza per una sostituzione.

• **CONNESSIONE**: Tutti gli ingressi e le uscite (ad eccezione per l'ingresso di alimentazione) sono sorgenti di energia in classe 1 (ES1) come definito nelle normative IEC/UL 62368-1 edizione 2. Limiti ES1: 60Vdc or 30V rms/ 42.4V di picco.

• **RIPARAZIONI E ASSISTENZA**: L'utilizzatore non deve in nessun caso cercare di riparare l'apparecchiatura, poiché con l'apertura del coperchio metallico o di qualsiasi altro pezzo costituente la scatola metallica,

nonché svitare le viti che appaiono esteriormente, poiché ciò può provocare all'utilizzatore un rischio di shock elettrico o altri rischi. Non sostituire le batterie a bottone presenti all'interno dell'unità'.

- **APERTURE DI VENTILAZIONE:** Le apparecchiature possono comportare delle aperture di ventilazione, si prega di non introdurre mai oggetti o ostruire le sue fessure. Se un liquido o un oggetto penetra all'interno dell'apparecchiatura, disconnetterla e farla controllare da personale qualificato prima di rimetterla in servizio.

3.1.4 German

Um den Betrieb dieses Geräts zu verstehen, raten wir Ihnen vor der Inbetriebnahme alle Sicherheits- und Betriebsanweisungen genau zu lesen. Diese Sicherheits- und Betriebsanweisungen für einen späteren Gebrauch sicher aufbewahren. Alle in den Unterlagen, an dem Gerät und hier angegebenen Sicherheitsanweisungen einhalten.

- **ACHTUNG:** Nicht für Kinder geeignet. Um jegliches Risiko eines Stromschlags oder Feuers zu vermeiden, das Gerät nicht Regen, Feuchtigkeit oder intensiven Wärmequellen aussetzen.

- **EINBAU:** Eine ausreichende Luftzufuhr sicherstellen, um jegliche Überhitzung im Gerät zu vermeiden. Das Gerät nicht auf und in Nähe von Textiloberflächen, die Belüftungsöffnungen verschließen können, aufstellen. Das Gerät nicht in Nähe von Wärmequellen, wie z.B. Heizkörper oder Warmluftkappe, aufstellen und es nicht dem direkten Sonnenlicht, übermäßigem Staub, Vibrationen oder mechanischen Stößen aussetzen. Dies kann zu Betriebsstörungen und Unfällen führen.

- **STROMVERSORGUNG:** Zuerst das Gerät erden bevor die Spannungsversorgung hergestellt wird. Verwenden Sie Erdungskabel und eine Schraube auf der Rückseite des Gehäuses, um das Gerät zu erden. Das Gerät nur mit der auf dem Gerät bezeichnete Stromquelle betreiben. Gerät mit geerdeter Hauptstromversorgung muss an eine Stromquelle mit effizienter Erdung angeschlossen werden. Diese Erdung darf auf keinen Fall geändert, umgangen oder entfernt werden. Anschluss von Geräten ans Stromnetz muss nach Abzweigschalter des Gebäudes Installation.

NETZKABEL: Das Gerät ist mit zwei oder drei lösbaren Netzkabel ausgestattet; um es völlig vom Netz zu trennen, ziehen Sie bitte die Netzkabel aus der Kaltgerätebuchse.

Achtung: Das Netzkabel stellt die einzige Möglichkeit dar, das Gerät vollständig vom Netzanschluss zu trennen.

Bitte beachten Sie die folgenden Hinweise:

- Wenn Geräte dauerhaft am Netz bleiben, müssen sie über eine leicht zugängliche Trennvorrichtung verfügen, die außen am Gerät angebracht sein muss.
- Das Kabel mittels des Steckers herausziehen. Niemals am Stromkabel selbst ziehen.
- Die Steckdose muss sich in der Nähe des Geräts befinden und leicht zugänglich sein.
- Das Stromkabel nicht fallen lassen und keine schweren Gegenstände darauf stellen.

Wenn eines der beiden Stromkabel beschädigt ist, das Gerät sofort abschalten. Es ist gefährlich, das Gerät mit einem beschädigten Stromkabel zu betreiben; ein abgenutztes Kabel kann zu einem Feuer oder Stromschlag führen. Die Stromkabel regelmäßig untersuchen. Für Ersatz wenden Sie sich an Ihren Verkäufer oder eine Kundendienststelle.

- **ANSCHLÜSSE:** Alle Eingänge und Ausgänge (ausgenommen der Stromversorgung) entsprechen der der ES1 Klassifizierung entsprechend der IEC/UL 62368-1 Edition 2. ES1 max. Auslegung: 60Vdc oder 20V rms / 42,4V Spitze.

- **REPARATUR UND WARTUNG:** Der Benutzer darf keinesfalls versuchen das Gerät selbst zu reparieren, die Öffnung des Geräts durch Abnahme der Abdeckhaube oder jeglichen anderen Teils des Gehäuses sowie die Entfernung von außen sichtbaren Schrauben zu Stromschlägen oder anderen Gefahren für den Benutzer führen kann. Die Knopfzelle der Einheit darf nicht getauscht werden. Wenden Sie sich an Ihren Verkäufer, Ihre Kundendienststelle oder an qualifizierte Fachkräfte.

- **ÖFFNUNGEN UND MUNDUNGEN:** Die Geräte können über Öffnungen verfügen (Belüftung, Schlitze, usw.). Niemals Gegenstände in die Öffnungen einführen oder die Öffnungen verschließen. Wenn eine Flüssigkeit

oder ein Gegenstand in das Gerät gelangt, den Stecker herausziehen und es vor einer neuen Inbetriebnahme von qualifiziertem Fachpersonal überprüfen lassen.

3.1.5 Spanish

Para comprender mejor el funcionamiento de este aparato, le recomendamos que le acudadosamente todas las consignas de seguridad y de funcionamiento del aparato antes de usarlo. Conserve las instrucciones de seguridad y de funcionamiento para que pueda consultarlas posteriormente. Respete todas las consignas indicadas en la documentación, relacionadas con el producto y este documento.

- **CUIDADO:** No recomendado para niños. Para prevenir cualquier riesgo de choque eléctrico y de incendio, no exponga este aparato a la lluvia, a la humedad ni a fuentes de calor intensas.
- **INSTALACIÓN:** Cerciórese de que haya una circulación de aire suficiente para evitar cualquier sobrecalentamiento al interior del aparato. No coloque el aparato cerca ni sobre una superficie textil que pudiera obstruir los orificios de ventilación. No instale el aparato cerca de fuentes de calor como radiador o boca de aire caliente, ni en un lugar expuesto a los rayos solares directos o al polvo excesivo, a las vibraciones o a los choques mecánicos. Esto podría provocar su mal funcionamiento o un accidente.
- **ALIMENTACIÓN:** Conecte la toma de tierra antes de conectar el equipo al suministro eléctrico. Utilice un cable para conectar cualquier tornillo del chasis, con la toma de tierra de la instalación. Ponga a funcionar el aparato únicamente con la fuente de alimentación que se indica en el aparato. Los aparatos deben estar conectados obligatoriamente a una fuente equipada con una puesta a tierra eficaz. Por ningún motivo este enlace de tierra deberá ser modificado, cambiado o suprimido. Conexión del equipo a la red eléctrica debe ser posterior del interruptor de circuitos derivados de la instalación del edificio.
- **CABLES DE ALIMENTACION:** El equipo puede ser equipado de 2 o 3 cables de alimentación, si desconectamos los cables dejamos al equipo sin alimentación.

Atención: Los cables de alimentación constituyen el único medio de desconectar el aparato totalmente de la red eléctrica.

Aplicar las siguientes consignas:

- El material conectado a residencia a la red informática, debe de tener un dispositivo de seccionamiento fácilmente accesible que debe de ser incorporado al exterior del aparato.
- Desconectar el aparato del enchufe mural si no piensa utilizarlo durante varios días.
- Para desconectar los cables, tire de la clavija. No tire nunca de los cables propiamente dichos.
- El enchufes de alimentación debe estar cerca del aparato y ser de fácil acceso.
- No deje caer los cables de alimentación ni coloque objetos pesados encima de ellos.

Si uno de cables de alimentación sufriera algún daño, ponga el aparato inmediatamente fuera de tensión. Es peligroso hacer funcionar este aparato con un cable averiado, ya que un cable dañado puede provocar un incendio o un choque eléctrico. Verifique el estado los cables de alimentación de vez en cuando. Póngase en contacto con su distribuidor o con el servicio de posventa si necesita cambiarlo.

- **CONEXIONES:** Todas las entradas y salidas (excepto la entrada de corriente) son de nivel eléctrico clase 1 (ES1) tal como se define en la norma IEC / UL 62368-1 2. Límites de ES1 60 VCC ó 30 V rms / 42,4 V de pico.
- **REPARACIÓN Y MANTENIMIENTO:** Por ningún motivo, el usuario deberá tratar de efectuar operaciones de reparación, ya que si abre los aparatos retirando el capó o cualquier otra pieza que forma parte de las cajas o si destornilla los tornillos aparentes exteriores, existe el riesgo de producirse una explosión, choques eléctricos o cualquier otro incidente. No reemplace la pila de botón, presente en la unidad. Contacte el servicio de posventa, a su distribuidor o diríjase con personal cualificado únicamente.
- **ABERTURAS Y ORIFICIOS:** Los aparatos pueden contener aberturas (aireación, ranuras, etc.). No introduzca allí ningún objeto ni obstruya nunca estas aberturas. Si un líquido o un objeto penetra al interior del aparato, desconéctelo y hágalo revisar por personal cualificado antes de ponerlo nuevamente en servicio.

3.1.6 Environmental specifications for all LivePremier models

General:

- Cooling air flows from front side to rear.
- Max ambient operating temperature: < 40°C (< 104°F).
- Operating temperature: 0 to +40°C / +32°F to +104°F
- Storage temperature: -10 to +60°C / +14°F to +140°F
- Operating humidity: 10 to 80% (non condensing)
- Input voltage range: 100-240 VAC autosensing, 50/60 Hz 7A

Safety standard:

- IEC/EN/UL 62368-1
- CSA C22.2#62368-1

Electromagnetic compatibility:

- EN55032
- EN55024
- EN61000-3-2
- EN61000-3-3
- CFR47 Part 15
- ICES-003

Environment:

- RoHS
- WEEE

Caution: Should the unit lose power unexpectedly; unsaved settings may be lost.

3.1.7 UPS compatibility

LivePremier units are only compatible with online (or double conversion) Uninterruptible Power Supply systems (UPS) with no switching delay. Offline and Inline UPS are not supported.

3.2 Package Contents

The LivePremier sales package includes:

- One LivePremier unit
- Two or Three power cords depending on the LivePremier model
- One Rackmount kit
- One Ethernet cross cable
- One Quick start guide*

*The latest versions of the User manual and Quick start guide are also available on www.analogway.com

3.3 Rack mount information

All LivePremier units are equipped with 4 handy anti-slip rubber feet and can be used directly on a table. For rack mount installation, see document *LivePremier – Rack mount.pdf* attached to this manual.

4 Introducing LivePremier™

Before setting up the LivePremier for the first time, please read through all of the documentation to become familiar with its powerful features. The LivePremier can be used in multiple configurations, which results in a versatile video production tool for live event staging and fixed installation applications. LivePremier is not limited by pixel canvas size and can process up to 120 Megapixels throughput at 10 bits 4:4:4 @60Hz.

4.1 LivePremier – Modular architecture

LivePremier is designed to be modular. Input and Output cards can be replaced and every card is composed of four identical slots. Fixed models have been created for users looking for stable preconfigured units (Freelance, Rental or Staging). All other units are considered Custom versions.

The LivePremier product range includes five fixed models and two customizable models:

Aquilon Models	RS alpha	RS1	RS2	RS3	RS4	C	C+
4K60p inputs	8	16	16	24	24	0 to 16	4 to 24
4K60p outputs	4	8	12	12	16	0 to 16	4 to 20
Max 4K60p PGM outputs	4	4 + 4 Aux	8 + 4 Aux	8 + 4 Aux	12 + 4 Aux	8 + 8 Aux	12 + 8 Aux
Max DL/2K60p mixing layers	8	8	16	16	24	up to 16	up to 24
Simultaneous 4K image channels	12	12	12	24	24	up to 12	up to 24
Rack units	4RU	4RU	4RU	5RU	5RU	4RU	5RU

Table 1 - LivePremier family

A fixed unit that has been modified becomes a Custom unit.

For more information on input/output cards, see [4.5 Input / Output cards](#) page 20.

4.2 Supported formats and rates

LivePremier supports a wide range of formats and rates including custom formats which can be created directly in the user interface.

- Max horizontal timings: 8192 pixels
- Max vertical timings: 4096 lines
- Max frequency/rate: 144Hz for Inputs, Outputs and Internal rate.

Note: - For more information on custom formats, see [12.1 Formats](#) page 81.

- Format with rates above 60Hz may not be supported by devices and accessories other than LivePremier devices (ex: DPH104, HDMI over fiber extenders, etc.).

4.3 Front panel

It is composed of one OLED display, two USB ports, three buttons (Power, Enter and Exit) and a coder. The front panel can be used for admin features or information (Firmware update, Network settings, Import/Export configuration, Factory Reset and Status check).



Fig. 1 - LivePremier 4RU and 5RU front panels

The front panel displays information such as device IP address, firmware version, or CPU and GPU status.

- Press the **Next/Status button** to wake the display and show device information.
- Press again to cycle through the next pages.

The display automatically goes off after 3 minutes of inactivity.

4.4 LivePremier rear panels



Fig. 2 - LivePremier rear panel (Aquilon C+) / virtual panel with Input/Output numbers (Aquilon RS4)

4.5 Input / Output cards

4.5.1 Available cards

Input and output cards can be replaced on field and every card is composed of four identical connectors. Each connector represents one input/output and supports formats up to 4K 60Hz 4:4:4 or 2560x1600@144Hz.

Option	Description
Input and output cards	4 x DisplayPort 1.2
	4 x HDMI 2.0
	4 x HDMI 2.0 over optical fiber
	4 x 12G-SDI*
	4 x 12G-SFP non MSA**
	4 x SDVoE (AV over IP)
Other	Filler input card or Filler output card

Table 2 - LivePremier optional input and output cards

*12G-SDI is fully compatible with 3G-SDI and 6G-SDI.

**12G-SFP input and output cards can receive SFP modules either for *SDI over Fiber* or for *SDI over IP / SMPTE*.

For more information, visit www.analogway.com or contact Analog Way support.

4.5.2 Change an input / output card

Warning: - Input / output cards are NOT hot swappable. The unit must be turned off and disconnected from power.

- Input / output card slots shall never stay empty when the device is turned on as it can cause long-term damage. If using the device with reduced input / output options, please use Filler input cards or Filler output cards in place of empty slots.
- Input cards cannot be used as output cards and vice versa.
- Do not force cards in places other than slots specified in *Fig. 2 - LivePremier rear panel (Aquila C+)* page 19.
- Do not remove cards other than input, output or control cards.

Installation rules: - Cards must be installed from top to bottom.

- LivePremier units must have 2, 4 or 6 input cards (no odd numbers).

Tip: - Input and output cards have different size and colors. Note that output cards are black.

- Inputs and outputs are numbered in rows from left to right and from top to bottom (see *Fig. 2 - page 19*).

Tools required: one cross-head screwdriver.

1. Turn off the LivePremier unit and disconnect all power supply.
2. Locate the card to change.
3. Loosen the screws on both sides of the card, use the screwdriver if needed.
4. Carefully place the card in the box provided.
5. Put the new card in place, keep a straight axis and pay attention to the rails.
6. Push the new card until mechanical stop to ensure the connection is correct.
7. Tighten the screws on both sides of the card, use the screwdriver.
8. Reconnect the power supplies and turn on the LivePremier unit.
9. Open the Web RCS to check the new card is correctly installed. If needed, update the LivePremier unit.

4.6 Fixed parts

The following parts are fixed and available on all LivePremier units (except the second Power supply unit on 4RU units).

Warning: - All parts other than input, output and control cards are fixed and should not be removed.



Fig. 3 - Fixed parts on all LivePremier units

4.6.1 Optional control card with DisplayPort Multiviewer outputs

Warning: - Changing the control card also changes the device configuration. If needed, export a configuration to recover it after the update (see 5.5 Save / Load Configuration page 34).

- The control card is NOT hot swappable. The unit must be turned off and disconnected from power.
- Do not force cards in places other than slots specified in Fig. 2 - LivePremier rear panel (Aquilon C+) page 19.

The control card with DisplayPort Multiviewer outputs is now available as an option or an accessory. A LivePremier device can be equipped with two DisplayPort 1.2 Multiviewer outputs instead of the HDMI 2.0 plugs. These DisplayPort plugs support the DPH104 and can feed up to eight full HD displays. To change the control card, follow the same procedure as 4.5.2 Change an input / output card page 20.

Note: For more information about setting DPH104 on a Multiviewer output, see 7.2.2 Set a DPH104 for a Multiviewer DP output page 49.

4.6.2 USB and sync ports

All LivePremier units are equipped with four USB ports (two on the front panel, two on the rear panel). The sync ports can be used to synchronize LivePremier units with other devices.

Note: All sync ports are independent and can be used equally.

4.6.3 Framelock

A Framelock is used to synchronize the frame rate of multiple devices with a physical connection.

- The Framelock input is used to synchronize the LivePremier unit with an external reference.
- The Framelock loop connector is then used to send the sync signal to other devices.
- The Framelock output can also be used alone (as a sync signal generator).

4.6.4 GPIO

All LivePremier units are equipped with 3x MCO 5 pin connectors:

- 1x On/Off
- 2x GPI
- 8x GPO

Note: For more information on GPIO settings, see 13.3 GPIO page 87.

4.6.5 Dante audio connectors

All LivePremier units are equipped with two dedicated Dante connectors to support up to 64 (8x8) audio input channels and 64 (8x8) audio output channels at 48 kHz.

Dante audio can only be controlled from the Dante ports used as primary & secondary connections. The Dante network is a network dedicated to audio and separated from the LivePremier network.

Note: For more information on Audio settings, see *13.1 Audio* page 84.

4.6.6 Power supply units

Recommendation: Use all powers supply units to optimize performance and redundancy.

LivePremier units can be equipped two or three Power supply units (PSU):

- 4RU units include 2 PSUs.
- 5RU units include 3 PSUs.

In nominal use there is power load balancing between the PSUs for optimized performance.

One PSU can fail without impacting performance (redundancy 1+1 or 2+1).

A 5RU LivePremier unit cannot function with only one PSU working.

4.6.6.1 Power supply compatibility

Caution: - Only use power supplies provided or recommended by Analog Way.

- Ensure that all power supplies present on the unit are from the same type (type 1 or type 2).
- Do not use different types of power supplies in the same unit as it may damage the unit.

Because the LivePremier is modular, the power supplies can be removed and swapped between units.

However, the LivePremier product line uses two different models for the power supplies (type 1 and type 2).

Please note that they are not compatible with each other.

4.6.6.2 Power supply noise on standby

When a LivePremier unit is connected to power, some power supply fans will start running to cool down. Please note that this noise is normal even if the unit is on standby.

4.6.6.3 Power supply noise on start up

When starting the LivePremier, some power supplies might be noisy depending on the reference. Please note that this noise is normal though it should not exceed 20 seconds. If needed, Power supplies status can be checked in the Web RCS.

Note: For more information, see *5.4 Dashboard - System settings*, page 30.

4.6.7 LivePremier accessories

For more information on LivePremier accessories, visit www.analogway.com or contact Analog Way support.

4.6.7.1 HDMI 2.0 over fiber extenders – Transmitter and Receiver



Fig. 4 - HDMI 2.0 over fiber extender

The extenders are designed to transfer HDMI 2.0 signal with embedded audio over one multimode fiber cable. One extender cable supports resolutions up to 4K60 or custom formats such as 8192×1080@60Hz. Max distance: 2500m / 8000ft. for Full HD - 600m / 500ft. for 4K60.

4.6.7.2 Rack-mountable power tray for optical extenders



Fig. 5 - Power tray for optical extenders (ex: Neutrik OpticalCON Duo)

There are three types of power trays with different connectors:

- 4x Neutrik opticalCON Duo + 8 slots for HDMI 2.0 over fiber extenders
- 4x Neutrik opticalCON Quad + 16 slots for HDMI 2.0 over fiber extenders
- 8x SC Duplex + 16 slots for HDMI 2.0 over fiber extenders

The power tray is a 1RU size housing accessory which can enclose up to 8 or 16 extenders, also providing power source for every installed device. The optical fibers are connected to the Neutrik opticalCON Duo, Neutrik opticalCON Quad, or SC Duplex connectors each carrying signal fibers from the extenders. The HDMI tail cables of the extenders are accessible directly at the back of the power tray.

4.7 Power on and off

4.7.1 Start the LivePremier

To start the LivePremier unit safely and correctly:

1. Connect all inputs and outputs.
2. Connect the power cables to the unit and then plug them into a mains socket.
3. Press the power button on the front panel.

4.7.2 Power off

Tip: - The following procedure is the recommended method to safely turn off the LivePremier unit.

- Saving the configuration before powering off is not necessary. The unit saves the current configuration in real time.

4.7.2.1 Power off from the Front panel

To turn off the LivePremier unit, press the Power button then press the Enter button to confirm.

4.7.2.2 Power off from the Web RCS

Click  in the Web RCS top bar, then click **Standby** and confirm.

4.7.3 Forced shutdown

Caution: Use forced shutdown only if the unit has crashed. Using forced shutdown regularly is not recommended.

If the LivePremier unit crashed, turn off the power by Forced shutdown.

- Press and hold the Power button on the front panel until shutdown.

4.8 Precautions when mounting a LivePremier unit

Warning: - For safety reasons, it is recommended to earth the unit. Use an earth cable (not provided) to earth a screw of the unit's chassis.

- Follow these precautions to avoid risks for products and users.

- Do not put a magnetic plate in contact with the upper part of the unit as it may block the fans of the unit.

When mounting the LivePremier unit, ensure proper air flow and consider the following points on safe use.

- Always use the handles built on the sides of the chassis for easy mounting into any standard rack or flight case.
- Remove the front and back panels of the flight case during operation to provide enough air flow through the unit and prevent overheating.
- Place the unit preferably in a cool and dry environment.
- The fans inside the unit expel the heat through the front and rear panels. Therefore, it is crucial that both the front and the rear are always unobstructed. A minimum of 50 cm (20 in.) of clear space at the front and rear of the unit is recommended.
- Do not block the ventilation.
- Do not place any fluid above or near the unit.
- Do not place any magnetic equipment on or near the unit.
- Do not apply any pressure against the chassis or the connectors.

5 Using the Web RCS

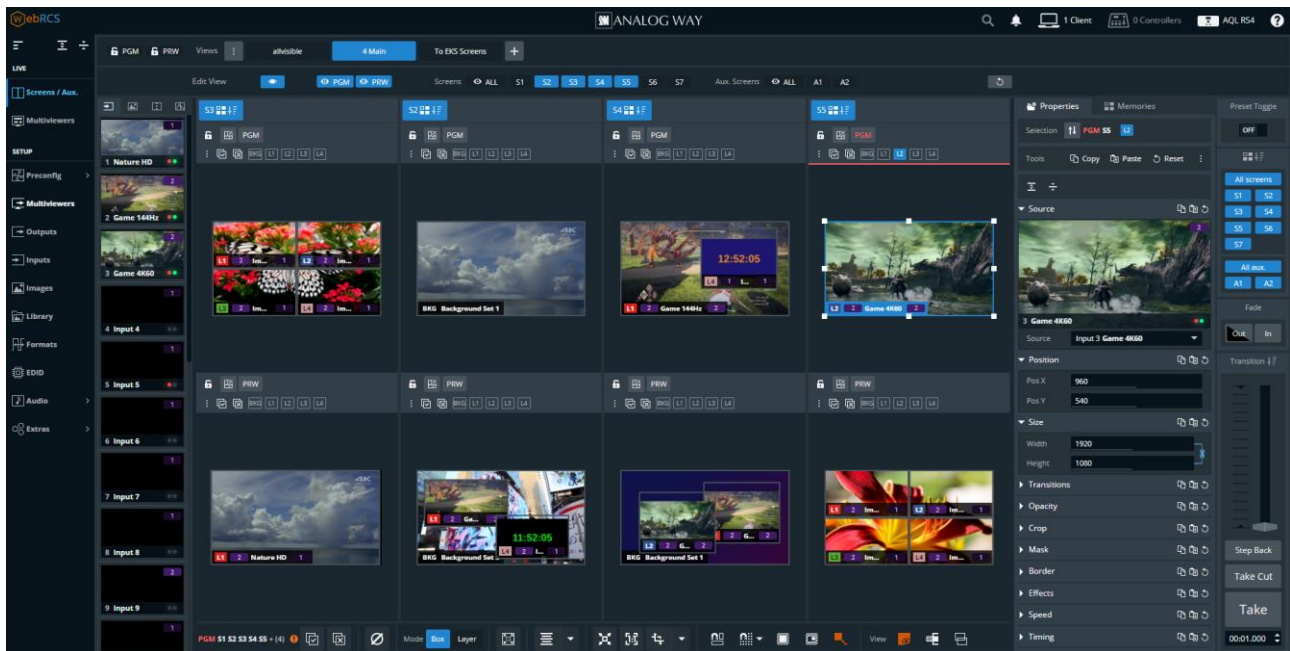

Fig. 6 - Web RCS Interface

The **Web RCS** is the main controller for the LivePremier. It is embedded in all units and compatible with all operating systems. LivePremier can be operated from any computer via wired network connection without installing any software.

LivePremier units can also be controlled from their dedicated controller: the **RC400T**.

Note: - For more information, see *Appendix A RC400T* page 118.

- Control can also be integrated into automation and control systems, for more information, contact your local technical support.
- The Web RCS supports both HTTP and HTTPS protocols.

5.1 Run the Web RCS

5.1.1 Web RCS requirements

- 1Gb Ram
- 200Mb of free space
- 100Mb Network adaptor or above
- 1920x1080 is the minimum and optimized screen resolution

Operating system:

- Windows 7 or above
- Mac OS v10.7 or above
- Ubuntu v10 or above
- Linux OS 11 or above

Web browser:

- Chrome (Recommended)
- Firefox
- Edge
- Opera
- Safari

Recommendation: Use the latest version of the web browser and keep it up to date.

The **Web RCS** is based on HTML5 and does not require Flash. It is optimized for Chrome web browser in full screen mode.

5.1.2 Default network settings

Connect a computer to the LivePremier unit via LAN connection. Use a crossover cable if connecting directly to the unit or use straight cables if connecting through a switch or hub.

Tip: All connections should be done before starting the LivePremier unit.

Default network settings:

IP Address: 192.168.2.140

Subnet Mask: 255.255.255.0

Port: 80

Note: Make sure that ports 80, 443, 10591, 10606, 10691, 10692 and 10693 are available on your network and/or not blocked by firewall.

To connect to this address, a computer needs to be configured to use a unique IP address on the same network. If this setup is part of a larger network with other devices, please check with your network administrator before plugging these devices into the network to avoid any IP address conflicts.

Example of static IP address on one computer:

Computer IP address: 192.168.2.50

Computer Subnet Mask: 255.255.255.0

5.1.3 Connection

To access the **Web RCS**, launch a web browser and enter the LivePremier IP address in the address bar. It is possible to connect multiple computers to the same LivePremier unit for real-time collaboration.



Fig. 7 - Web RCS connection

All devices default IP addresses are **192.168.2.140**.

Tip: Computers using energy saving mode may turn off the network adaptor during periods of inactivity. Disable the energy saving mode to ensure the connection remains active.

5.1.4 Login page

If conditional access is needed, the Web RCS can be protected by a password.

Note: For more information, see 5.4.3 Dashboard – Remote Access page 31.

5.1.5 LivePremier Simulator

The LivePremier Simulator is available on www.analogway.com.

Using the simulator, it is possible to simulate any LivePremier series multi-screen live presentation system on PC or Mac, and then launch the integrated Web RCS. It is the perfect tool to practice or rehearse when using a real unit is not possible. It is also a free opportunity to discover the Web RCS for the first time and learn the LivePremier concepts.

Tip: Configurations created in the simulator can be exported/imported to a real unit, including the image library.

Note: For more information about using LivePremier Simulator, see the Quick Start Guide available on www.analogway.com

5.2 General tips

5.2.1 Web browser features

The Web RCS is fully browser integrated and behaves like any web site.

It manages browser features such as:

- Previous page / Next Page
- Multi-selection of items using the Ctrl or Shift keys
- Open in new tab / Open in new page
- Enter direct URL
- Bookmark any page
- Supports browser-based language translators

5.2.2 Mobile version

Prerequisite: to access the LivePremier with a mobile device, a wi-fi router must be connected on the same network as the LivePremier unit.

A lighter version Web RCS is also available on iOS and Android mobile devices without any installation needed. To access the Web RCS from a mobile device, launch a web browser and enter the LivePremier IP address in the address bar.

This mobile version is simplified and has less features (no Preconfig or setup):

- Check device status
- Check rear panel connection status
- Check input video signals
- Load Master memories, Screen memories and Multiviewer memories
- Trigger transitions

Tip: For an optimized interface, do not display the mobile browser in Desktop mode.

5.2.3 Section buttons (copy, paste and reset)

On multiple pages of the Web RCS, the following buttons appear:



: Copy the settings



: Paste copied settings



: Reset the settings

These buttons are associated to a specific section. Use these buttons to quickly copy, paste or reset the settings of one section. Paste works when similar settings are currently copied (i.e. layer position copied to a different layer in a different screen).

5.2.4 Set a number value

In the Web RCS, the fields for number values can be set and adjusted in different ways:

- Click and enter a number value
- Click the field and hold then move the mouse left or right
- Click and use the scroll wheel for small adjustments (mouse must remain in the field)
- Click the *Up* and *Down* arrows at the end of the field for single unit adjustment

5.2.5 Search bar

In the top bar, use the search bar to simply access a feature or setting.

1. Click the search bar.
2. Enter a keyword to search (ex: Input, Pattern, Keying).

The search results are displayed.

3. Click a result to open the corresponding page.

5.2.6 Alarms and notifications

In the top bar, alarms and notifications display when the following events occur:

- A component is missing or not detected
- A component is not compatible with the current firmware version
- A high temperature has been measured (card, fan, or device alarm)
- Pending changes are waiting to be applied

Open the history log to check history of alarms and notifications.

It is possible to mark notifications as read or clear them all.

Tip: On the device front panel, the buttons **Enter** and **Exit** blink when an alarm is triggered. The blinking stops when the alarm stops (ex: temperature becomes normal again).

5.3 Device control synchronization

A LivePremier device can be connected to multiple control instances (multiple Web RCS page, RC400T, etc.). From the Web RCS, it is possible to set if one control instance is synchronized or desynchronized with the server.

When a control instance is synchronized with the server, the layer selection and the selection of Screens affected by transitions are applied to all other synchronized control instances (Web RCS page, RC400T, etc.).

Tip: By default, synchronization to server is disabled on all instances to work without other instances changing the layer selection or the selection of Screens affected by transitions.

5.3.1 Web RCS synchronization

1. In the top bar, click .

The sync status of the current Web RCS page is displayed as well as the number of currently opened Web RCS pages.

2. Toggle **Selection Synced to Server** to enable / disable synchronization to other control instances.

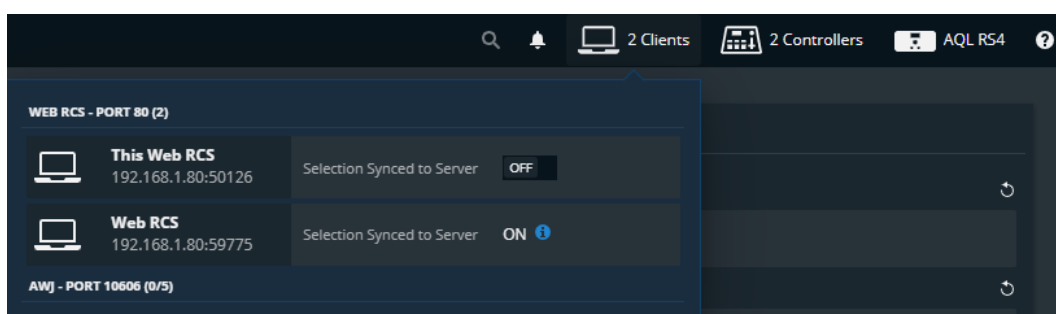



Fig. 8 - Web RCS synchronization

5.3.2 RC400T synchronization

1. In the top bar, click .

The sync statuses of the connected RC400T controllers are displayed.

2. Toggle **Selection Synced to Server** to enable / disable their synchronization to other control instances.

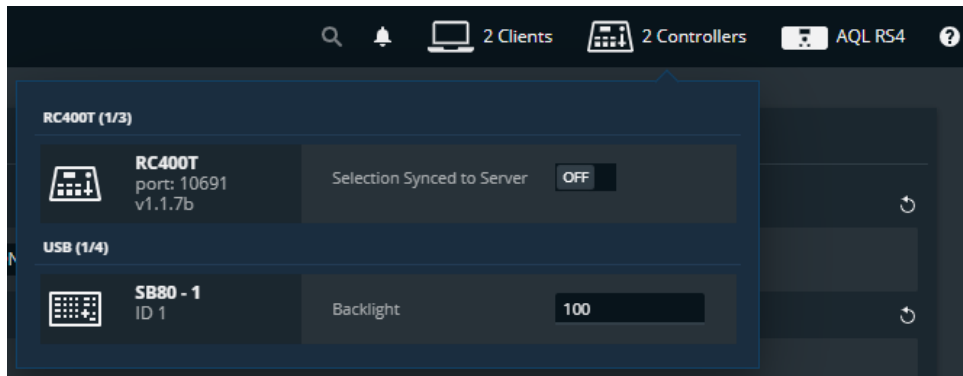



Fig. 9 - RC400T synchronization

Tip: Program and Preview Screens that are protected by lock in the Web RCS cannot be modified by the RC400T when synchronized to server. Layers cannot be modified; Memories cannot be loaded but transition can be triggered. For more information on Screen lock, see *14.1.1 Program and Preview* page 90.

5.3.3 Back panel shortcuts

In the top bar, click  to show the virtual Back panel.

Click the connectors to access their settings directly.

5.3.4 Standby / Restart

In the top bar, click  then **Standby** or **Restart** and confirm.

5.4 Dashboard - System settings

In the **Dashboard**, check device status and modify general system settings.

In the top bar, click  then any sub item of the Dashboard to enter the Dashboard menu.

Click on Dashboard items on the left panel to open the corresponding settings on the right panel.

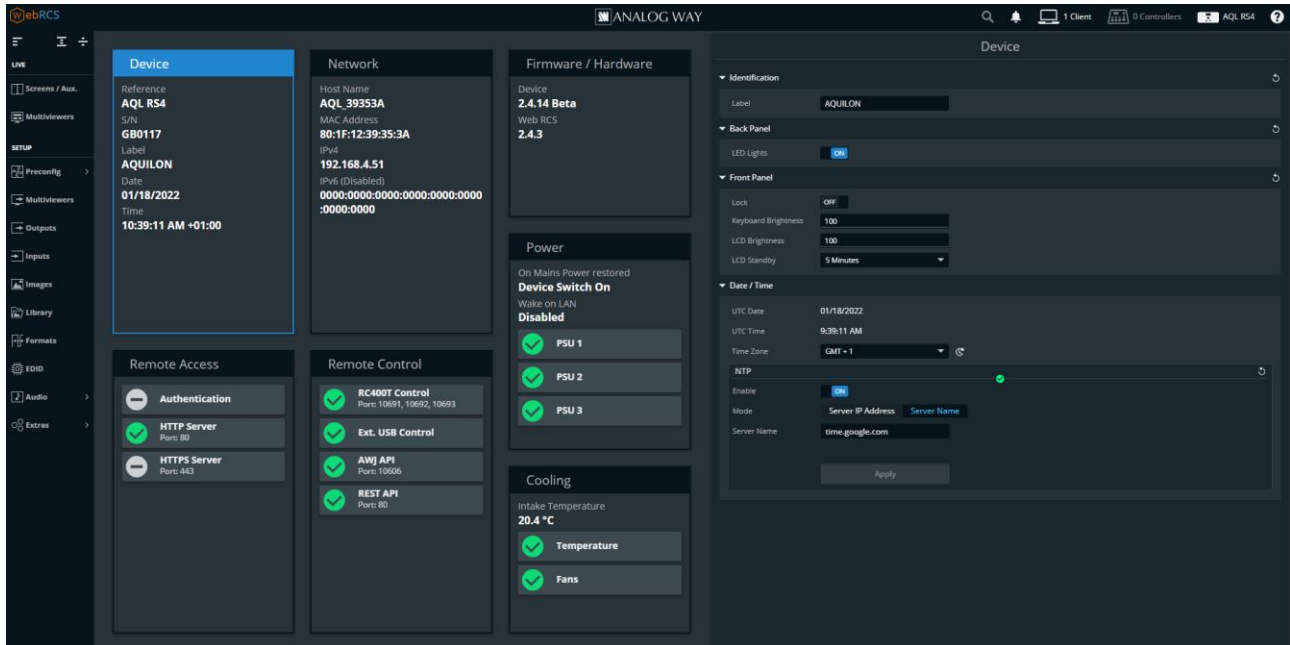



Fig. 10 - Dashboard

5.4.1 Dashboard – Device

1. In **Identification**, enter a name for the device.
2. In **Back Panel**, toggle the LED lights button to enable/disable the LEDs on the unit back panel.
3. In **Front Panel**,
 - a. Toggle the **Lock** button to lock the Front panel keys.
 - b. Set the Keys buttons Brightness.
 - c. Set LCD screen Brightness.
 - d. Set the LCD screen timeout before standby.

Caution: Disabling the LCD Standby may shorten the LCD backlight lifespan.

4. In **Date / Time**,
 - a. Set the device UTC Date and UTC Time. Click  to use local computer date or time.
 - b. If needed, set the Time Zone.
 - c. If using Network Time Protocol (**NTP**), toggle the Enable button.
 - d. Select **Server IP Address** and enter an IPv4 address or use DHCP, then apply.
Or select **Server Name** and enter a name, then apply.

Note: When using NTP, the first connection can last a few minutes. If the connection fails, the settings are not applied.

5.4.2 Dashboard – Network

1. Go to the **Dashboard > Network**.
2. In **Adapter**, set Host name.
3. In **IPv4**, manage DHCP, set IP address, Netmask, Gateway and DNS.
4. Click **Apply**.
5. If needed, enable and set **IPv6** and click **Apply**.

5.4.3 Dashboard – Remote Access

In **Dashboard > Remote Access**, enable / disable password protection for the Web RCS and enable HTTPS Server.

5.4.3.1 Default Web RCS password

By default, the password to access the Web RCS is the LivePremier unit MAC address.

The MAC address is displayed on the front panel of the unit and in the Web RCS in **Dashboard > Network**.

Note: The default password is 11:22:33:44:55:66 when using the LivePremier Simulator.

5.4.3.2 Enable Web RCS password protection

Note: Enabling password protection will disconnect all Web RCS pages currently opened.

1. Go to the **Dashboard > Remote Access**.
2. In **Basic Authentication**, toggle the Enable button.
3. Click **Apply**.

All opened Web RCS sessions are locked and return to a login page.

5.4.3.3 Lock an opened Web RCS session

To lock a session after logging in, close all instances of the web browser.

Tip: Reopen the web browser and try to access the Web RCS to make sure the session is locked.

5.4.3.4 Change Web RCS password

1. Go to the **Dashboard > Remote Access**.
2. In **Change password**, enter the new password.
3. Enter the same password to confirm.
4. Click **Apply**.

5.4.3.5 Reset Web RCS password from the front panel

If the password is lost or forgotten, it can be reset from the front panel of the LivePremier unit.

Note: The password can only be reset from the front panel.

1. On the Front panel, go to **Control**.
2. Go to **Reset Settings**.
3. Go to **Reset Auth. Password**.
4. **Apply**.

The Web RCS password is reset to default value (device MAC address).

5.4.3.6 Enable/Disable HTTP and HTTPS on the Web RCS

The LivePremier supports HTTPS protocol. It is possible to enable/disable HTTP and HTTPS.

Caution: Make sure port 443 is available on your network and/or not blocked by firewall to use HTTPS.

Tip: If the Web RCS is not accessible, use the front panel to re-enable the HTTP Server, see 5.4.3.8 *Reset HTTP and HTTPS settings*.

1. Go to the **Dashboard > Remote Access**.
2. In **HTTP Server**, toggle the enable button for HTTP.
3. In **HTTPS Server**, toggle the enable button for HTTPS.
4. Click **Apply**.

If HTTP has been disabled. The current page will be disconnected from the Web RCS.

Use **https://** before the device IP address to access the Web RCS in HTTPS (**https://192.168.2.140** by default).

5.4.3.7 Import custom HTTPS certificate

It is possible to import a private certificate and key to secure the connection to the device.

Note: Make sure port 443 is available on your network and/or not blocked by firewall.

1. Go to the **Dashboard > Remote Access**.
2. In **Current Certificate & Key**, load the certificate and private key files in the Web RCS using the file explorer or drag and drop.
3. Click **Upload**.
4. Click **Apply**.

5.4.3.8 Reset HTTP and HTTPS settings

Note: The HTTP and HTTPS settings can only be reset from the front panel.

1. On the Front panel, go to **Control**.
2. Go to **Reset Settings**.
3. Go to **Reset HTTP/HTTPS Servers**.
4. **Apply**.

The Web RCS HTTP and HTTPS settings are reset to default value (HTTP On and HTTPS Off).

5.4.4 Dashboard – Remote Control

In **Dashboard > Remote Control**, enable/disable Web RCS control via RC400T, external USB controllers or APIs.

5.4.4.1 Enable RC400T, external USB controllers and APIs connection

1. Go to the **Dashboard > Remote Control**.
2. In **RC400T Controllers**, enable/disable RC400T connection to the LivePremier unit.
3. In **External USB Controllers**, enable/disable Controllers connection to the LivePremier unit.
4. In **Application Programming Interfaces**, enable/disable LivePremier control via AWJ Protocol or REST API.

Note: The network ports used for RC400T and AWJ are displayed on the Remote Control card.

- For more information about RC400T, see *Appendix A RC400T* page 118.

- AWJ is a JSON based protocol developed by Analog Way for LivePremier. AWJ is a bidirectional TCP API, it grants full control on a LivePremier device and receives real-time status updates from the LivePremier device. For more information, visit www.analogway.com.

5.4.5 Dashboard – Firmware / Hardware (Firmware Update)

Prerequisite: Go to www.analogway.com and download the latest LivePremier updater.

Caution: Disconnect all HDMI over fiber cables from optical input plugs before a firmware update.

Note: In some cases, updating the LivePremier unit may reset the Configuration (check the Release notes).

Tip: Export a configuration to recover it after the update (see 5.5 Save / Load Configuration page 34).

5.4.5.1 Update Firmware from Web RCS

1. Go to **Dashboard > Firmware / Hardware**.
2. Load the updater file in the Web RCS using the file explorer or drag and drop.
3. Click **Extract selected file**.

The updater files are extracted and verified.

4. Click **Install**.

After the installation, the LivePremier unit reboots.

5. If needed, import saved Configuration.

Recommendation: Perform a default reset after a firmware update.

5.4.5.2 Update Firmware from the front panel

It is possible to update the firmware from the front panel using a USB drive.

1. Load the updater file on a USB drive (root).
2. Connect the USB drive to the front panel.

The LivePremier unit automatically detects updater files on the USB drive.

If the updater file is not detected, go to Control > Scan USB device using the front panel buttons.

3. Select **OK** to continue.
4. The available updater files are displayed, select a file.

The updater files are extracted and verified.

5. Select **Update**.

After the installation, the LivePremier unit reboots.

6. If needed, import saved Configuration.

Recommendation: Perform a default reset after a firmware update.

5.4.5.3 Reinstall current Firmware

When a firmware is installed, the LivePremier unit saves the installer of the current firmware in its memory. It is possible to reinstall the current firmware if needed (ex: update an input/output connector card).

1. Go to **Dashboard > Firmware / Hardware**.
2. Click **Extract current version**.

The updater files are extracted and verified.

3. Click **Install**.

After the installation, the LivePremier unit reboots.

4. If needed, import saved Configuration.

Recommendation: Perform a default reset after a firmware update.

5.4.5.4 Hardware status

The Hardware status is available if needed for System check or Technical support.

5.4.6 Dashboard – Power

Caution: always use same model of power supply units. If a new one is needed, be careful to use the same model.

1. Go to the **Dashboard > Power**.
2. In **Mode**, set **Device switch ON** or **Device stay OFF** when connected to power or after a power failure.
3. Enable / disable Wake on LAN.

5.4.7 Dashboard – Cooling

Caution: If the device temperatures are too high, the device will automatically shutdown to prevent damages.

Check the intake and internal device temperature. Two levels of alarms can appear if any temperature is too high: “abnormally high” and “dangerous”.

Recommendation: - In case of alarms, check that nothing is covering the unit and that the air flow is not blocked.

- Maintain the air filter regularly to prevent dust from blocking the air flow. For more information, see *17.1 User Maintenance – Air filter* page 117.

5.5 Save / Load Configuration

Tip: Saving the configuration before powering off is not necessary. The unit saves the current configuration in real time.

The LivePremier units can export and import device configurations.

In addition to these features, the LivePremier units also have two embedded memory slots to save and load configurations internally.

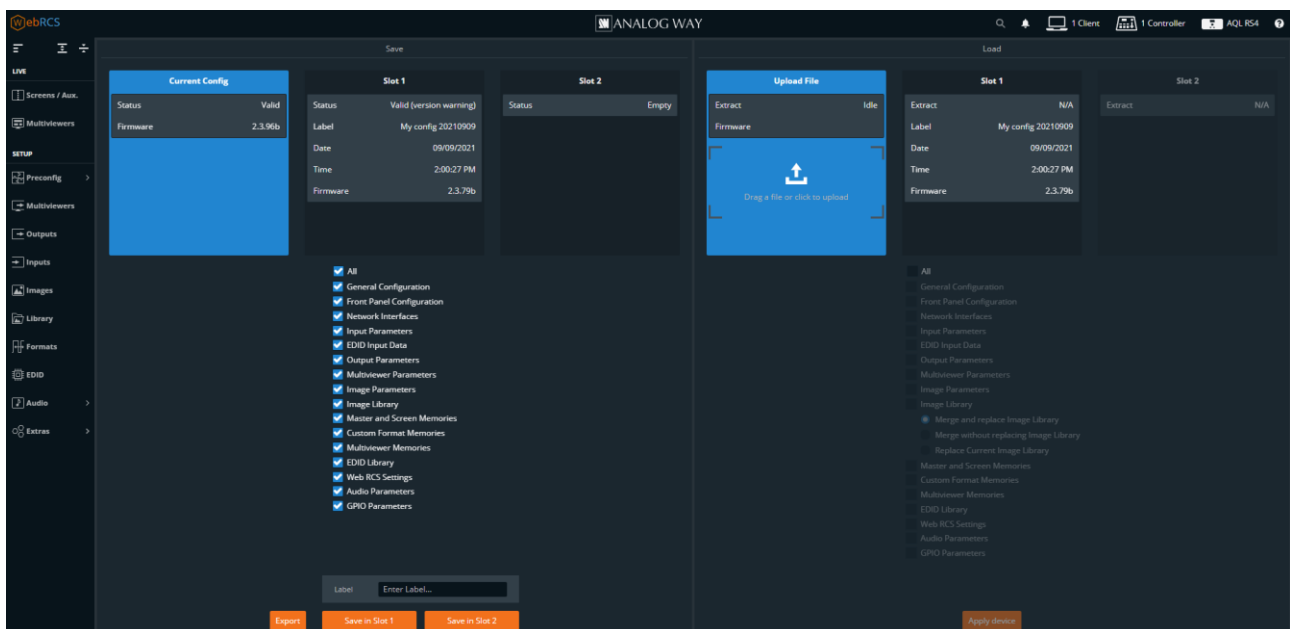



Fig. 11 - Save / Load Configuration

5.5.1 Save the current Configuration in a Slot

1. In the top bar, click , then **Save / Load**.
2. In the **Save** panel, click **Current Configuration**.
3. In the filters, select the settings to save.
4. Enter a label for the Configuration to save.
5. Click **Save to Slot 1** or **Save to Slot 2**.

The configuration is saved in the selected memory slot.

5.5.2 Load a Configuration from a Slot

1. In the top bar, click , then **Save / Load**.
2. In the **Load** panel, select the slot to load.
The configuration is extracted and conflicting settings are grayed out in the filters (version incompatibility, obsolete information, device logs, etc.).
3. In the filters, select the settings to load.
4. Select how to merge the images in the Library.

Merge and replace	Merge and replace images in non-empty slots
Merge without replacing	Merge but keep images in non-empty slots
Replace current Image Library	Replace the entire device library with the import library

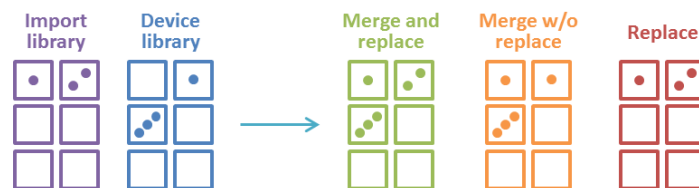

5. Click **Load**.

The configuration is loaded to the Web RCS and applied to the current configuration.

5.5.3 Export a Configuration to the computer

1. In the top bar, click , then **Save / Load**.
2. In the **Save** panel, select the configuration to export (**Current Configuration, Slot 1** or **Slot 2**).
3. In the filters, select the settings to export.

Note: Filtering is possible only if exporting the Current Configuration.

4. Click **Export**.

The configuration file is downloaded to the computer.

5.5.4 Import a Configuration

1. In the top bar, click , then **Save / Load**.
2. In the **Load** panel, click **Upload file** and select the configuration file to import.
Or drag and drop the configuration file from the computer file explorer to the **Upload file** area.
The configuration is extracted and conflicting settings are grayed out in the filters (version incompatibility, obsolete information, device logs, etc.).
3. In the filters, select the settings to import.
4. Select how to merge the images in the Library:

Merge and replace	Merge and replace images in non-empty slots
Merge without replacing	Merge but keep images in non-empty slots
Replace current Image Library	Replace the entire device library with the import library

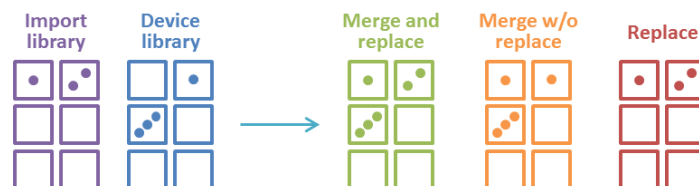

5. Click **Load**.

The configuration is loaded to the Web RCS and applied to the current configuration.

5.6 Reset configuration

1. In the top bar, click , then **Reset**.
2. Select the reset mode:

Default Reset	Select the settings to be reset to default value.
Out of the box	Factory reset. All settings are reset to default value.

3. Click **Reset**.

The LivePremier unit resets.

Recommendation: Perform a default reset after a firmware update.

6 LivePremier concepts

6.1 What is “Capacity”?

A capacity is the maximum bandwidth allocated to an item. Allocating a max capacity for every item ensures the interoperability between all the internal elements of a LivePremier unit. Capacities are automatically assigned when setting a format.

The range of the capacity is from **1** to **8**. The minimum capacity (**1**) refers to dual-link bandwidth. Each following capacity adds the resource equal to dual-link bandwidth. The maximum capacity (**8**) refers to 8K bandwidth.

6.1.1 Standard formats capacity

Here is a table showing some commonly used formats and their corresponding capacity:

Capacity 1 with internal rate at 60Hz	Capacity 2 with internal rate at 60Hz
1920 x 1080 @ 60Hz (HDTV 1080p60)	4096 x 2160 @ 30Hz
2560 x 1600 @ 60Hz	3840 x 2160 @ 60Hz (UHDTV 2160p60)
1920 x 1080 @ 120Hz	Between 1920 x1080 and 2560 x1600 @ 120Hz
Any format below 2560 x 1600 @ 60Hz	Any format above 2560 x 1600 @ 60Hz

Note: - Capacity depends on the device internal processing rate. The higher the internal rate, the more processing capacity will be required.
 - 4096 x 2160 @30Hz can be used as capacity **1** if the internal rate of the unit is set at 30Hz.
 - Some video formats and image resolutions are not supported when the internal rate is higher than 60Hz.
 For more information, see [7.1 Preconfig > System](#) page 47.

6.1.2 Elements using capacity

Tip: Capacities are automatically assigned when setting a format.

Inputs groups	Image slots	Layers	Screen output groups
Capacity 1	Capacity 1	Capacity 1	Capacity 1
Capacity 2	Capacity 2*	Capacity 2	Capacity 2

*Setting an image slot to capacity **2** disables the next image slot.

6.1.3 Content and layer compatibility

An input or image with capacity **1** can be used in a layer with capacity **1** or **2**:

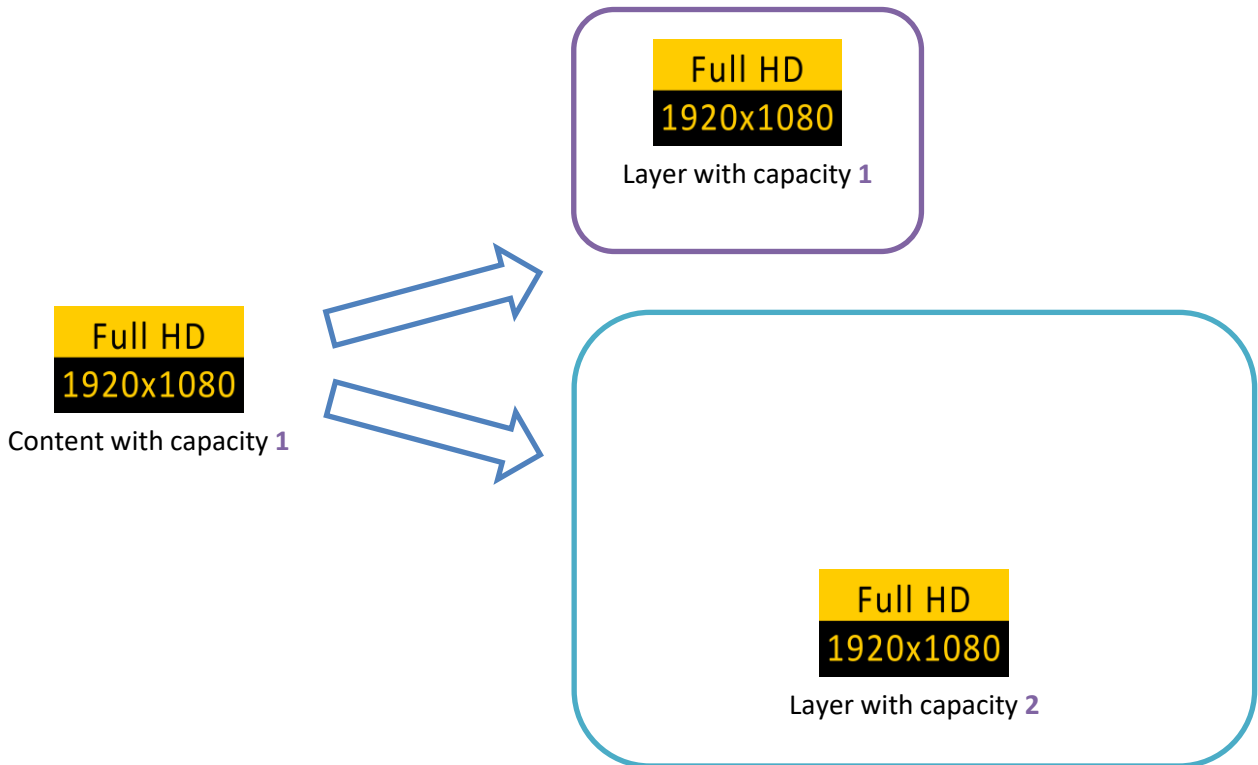

The content is displayed correctly but the resources are not optimized.

An input or image with capacity **2** can only be used in a layer with capacity **2**:

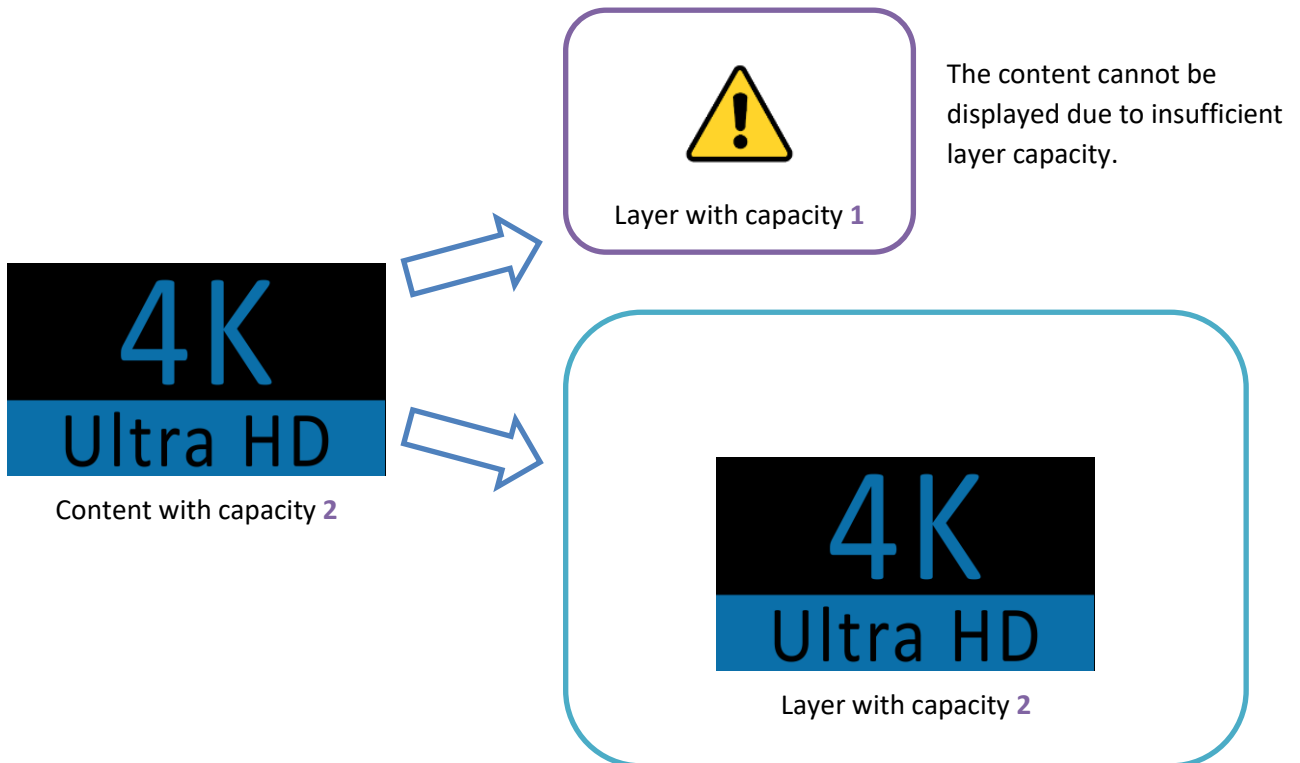

The content cannot be displayed due to insufficient layer capacity.

Note: If a 1920x1080 content is set to capacity 2, it will on be displayed in a layer with capacity 2.





6.2 Screen layers

Layers are assigned to Screens and Aux Screens in the Preconfig menu of the Web RCS. LivePremier features two layers modes exclusively for Screens: Mixing layers and Split layers.

Note: A Screen contains either mixing layers or split layers. But never a combination of both.

6.2.1 Screen sources

Screen and Aux Screen layers can display the following types of content:

-  Inputs
-  Image slots (images and timers)
-  Program Screens
-  Background sets

Note:

- Program Screens can only be used as content for Aux Screens and Screens in Split layer mode.
- Background sets can only be used in Screen Background layers.

6.2.2 Mixing layers

This is the default layers mode for LivePremier units as well as most Analog Way products. This offers the most spectacular transition effects which made the reputation of Analog Way.

Mixing layers allow cross transitions with both contents visible at the same time during the transition (seamless transition).

Note: A mixing layer cannot display a Program Screen.

6.2.3 Split layers

Layer mode that consumes half the processing resources compared to mixing layers and doubles the number of layers available on Screen. Split layers are created by pairs with same resource consumption (capacity **1** or **2**, use of Cut & Fill).

In split layers mode:

- A **Program Screen** can be displayed in a layer (may use resources of following layers and preempt them).
- Seamless transitions are not possible, one content will disappear before the new one is visible.
- When using a Multiviewer to view the Preview of a Screen using split layers, only layer wireframes are displayed.

6.3 Aux Screens and Aux layers

Aux Screens do not consume processing resources. They are a great help to display more content when the LivePremier unit has available outputs while processing resources are fully used by Screens.

6.3.1 Aux layers quantity and capacity

Outputs used in Aux Screens can display up to 8 layers with capacity **1**.

The Aux layer quantity follows two rules:

- Enabling more than 2 layers disables the next output plugs on the card as it uses their resources.
- Aux layers are dynamic. After the Aux Screen is created, assigning a content with a capacity higher than **1** will preempt the next Aux layer(s). One capacity needed = one layer preempted.

For example: an Aux Screen is set with 6 layers. Assigning a 7860x2160 Program Screen (capacity **4**) to layer 1 will preempt layer 2, 3 and 4. Layer 5 and 6 remain available.

Aux output layer quantity	Max source capacity if displaying only one layer
2 layers capacity 1	Capacity 2 (can display a 4K Screen)
4 layers capacity 1 (disables the next output slot)	Capacity 4 (can display a 2x 4K Screen)
6 layers capacity 1 (disables the next two output slots)	Capacity 6 (can display a 3x 4K Screen)
8 layers capacity 1 (disables the next three output slots)	Capacity 8 (can display a 4x 4K Screen)

Tip:

- Only outputs 1, 5, 9, 13 and 17 can be set as Aux Screens with 8 layers as this uses the resources of the next three outputs of the card. Connect outputs according to these limitations.
- An Aux with 8 layers has enough bandwidth to display an 8K Program, but the output plug format is still limited to 4K60.

6.3.2 Aux layers limitations

Aux layers support most of the same features as Screen split layers (input, image/timer, and screen program as source; size, position, crop, timings, etc.).

Aux layers do not support:

- Seamless transitions, one content will disappear before the new one is visible.
- Alpha channels, transparent content is displayed in the same color as the background layer.
- Border settings.
- Cut & Fill effect.

The Aux background layer can only support one monochrome color as a source (no input, image or background set).

6.4 LivePremier Processing

6.4.1 VPUs and Scaling engines

The main processing components of LivePremier are the Video Processing Units (VPU). VPUs create the layers and allocate them to one or multiple outputs. Understanding VPU concept is the key for optimized performance.

Each VPU contains 8 source links and 8 outputs links.

Capacity **1** uses one link and capacity **2** uses two links. Each VPU supports:

- 8 mixing layers (or 8 pairs of split layers) spread over 8 outputs, in capacity **1**.
- 4 mixing layers (or 4 pairs of split layers) spread over 4 outputs, in capacity **2**.

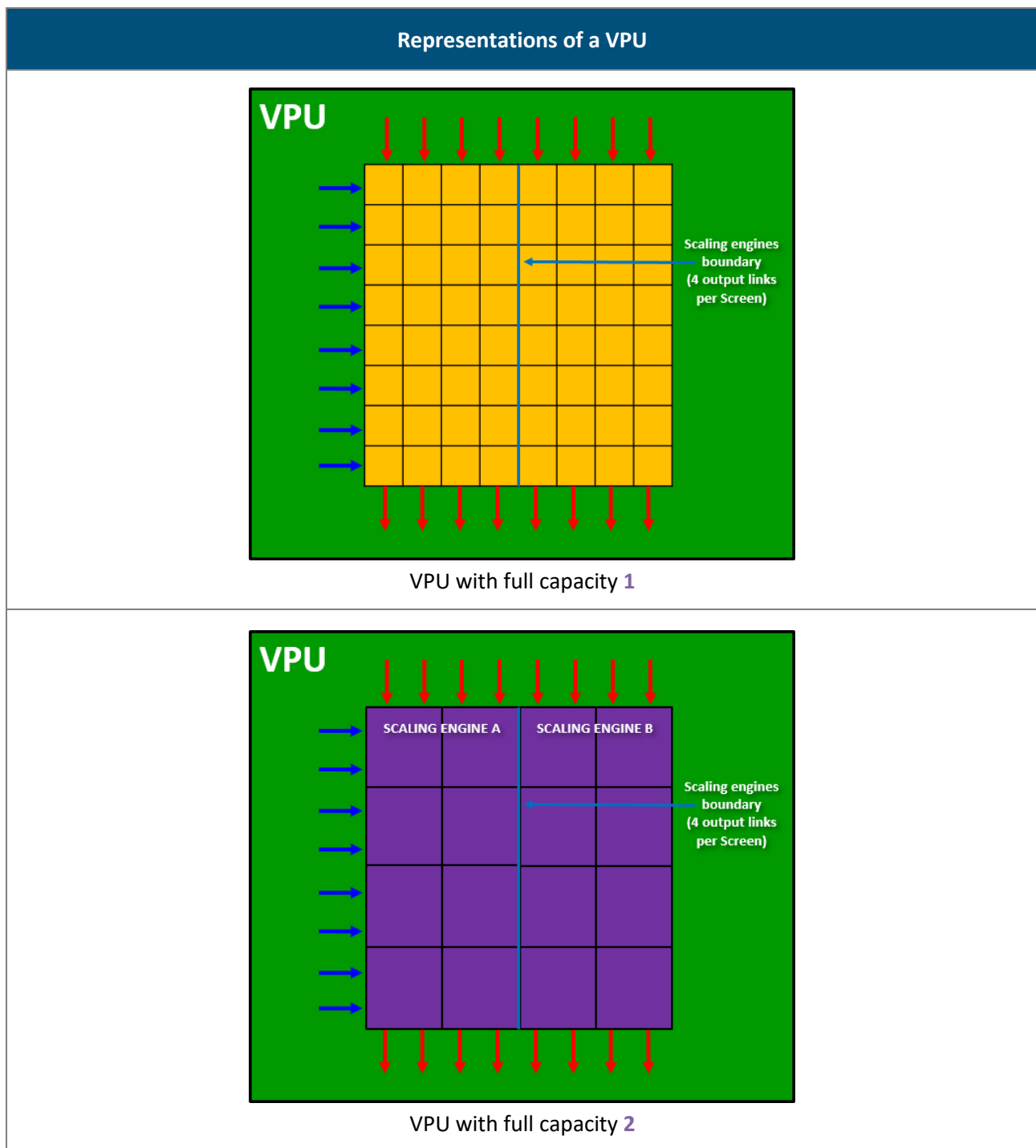

6.4.2 Self-rearrangement

A VPU has a modular architecture and rearranges its links depending on the Screen configuration:

- Number of outputs in the Screen
- Number of layers in the Screen
- Capacity of the links between layers and outputs

VPU configuration examples

One VPU can manage up to 8 Screens, each Screen using 1 output and 1 mixing layer.

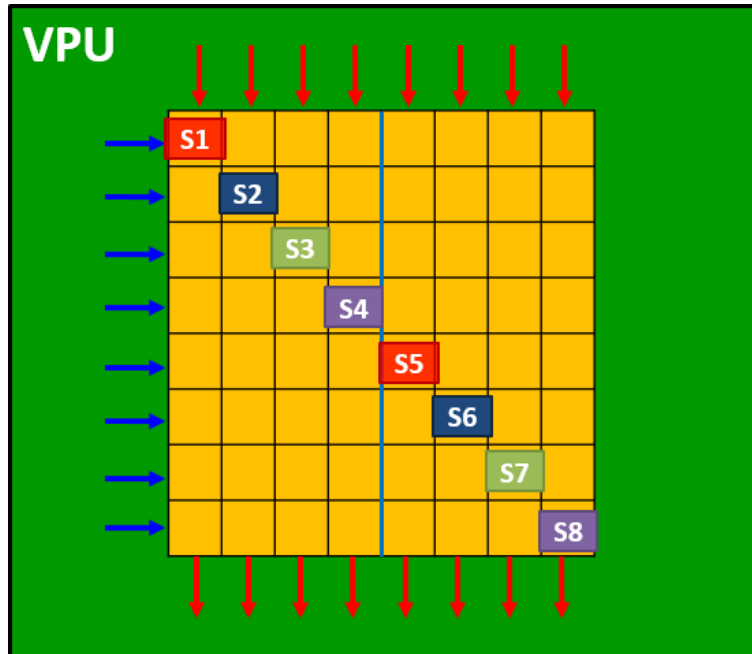

One VPU can manage various combinations within the 8x8 links limits:

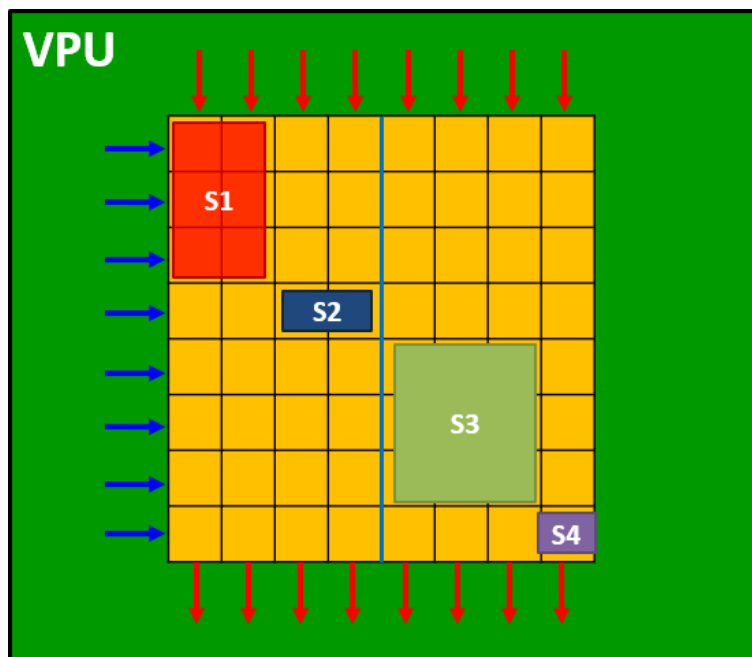

6.4.3 A VPU can support both capacities at the same time

One Screen cannot support mixing and split layers at the same time. However, VPUs and Screens can support layers of capacity 1 and 2 at the same time, in any order.

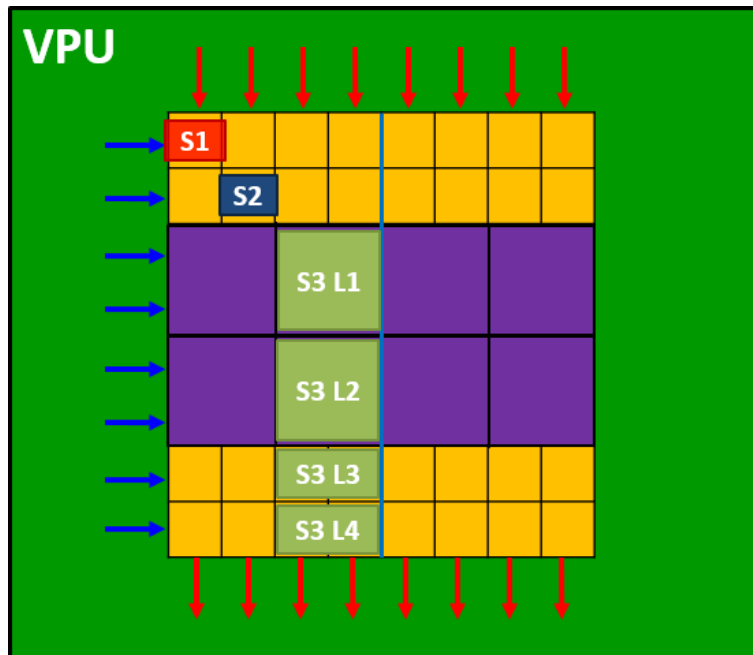

Screen 1 (1 output and 1 mixing layer capacity 1)
 Screen 2 (1 output and 1 mixing layer capacity 1)
 Screen 3 (2 outputs and 2 mixing layers capacity 2 and 2 mixing layer capacity 1)

6.4.4 Scaling engine boundary

A VPU is optimized to spread layers over up to 4 output links. A layer spread over more than 4 output links uses another layer link.

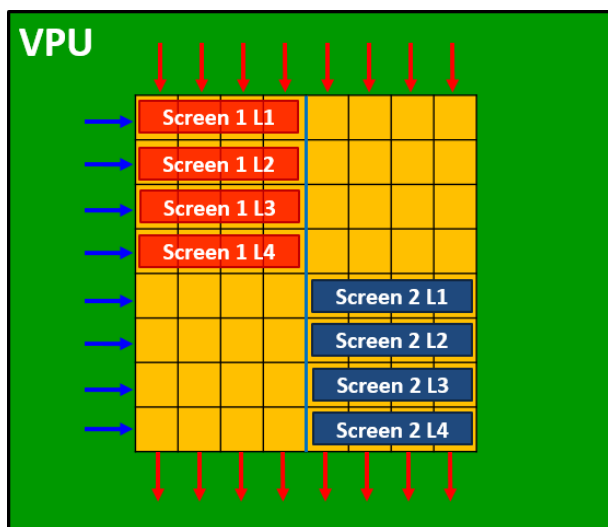

Two Screens of 4 outputs with 4 mixing layers each

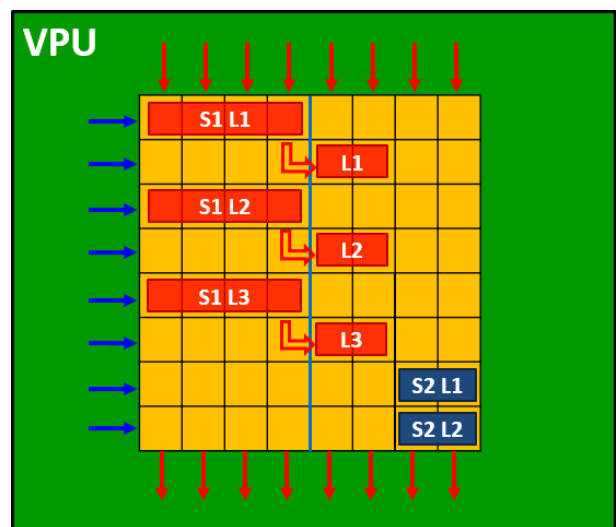

Screen 1 (6 outputs and 3 mixing layers)
 Screen 2 (2 outputs and 2 mixing layers)

6.4.5 Combined VPUs

A Screen using more than 8 outputs uses another VPU.

In the following example, each mixing layer of Screen 1 uses 3 layer links:

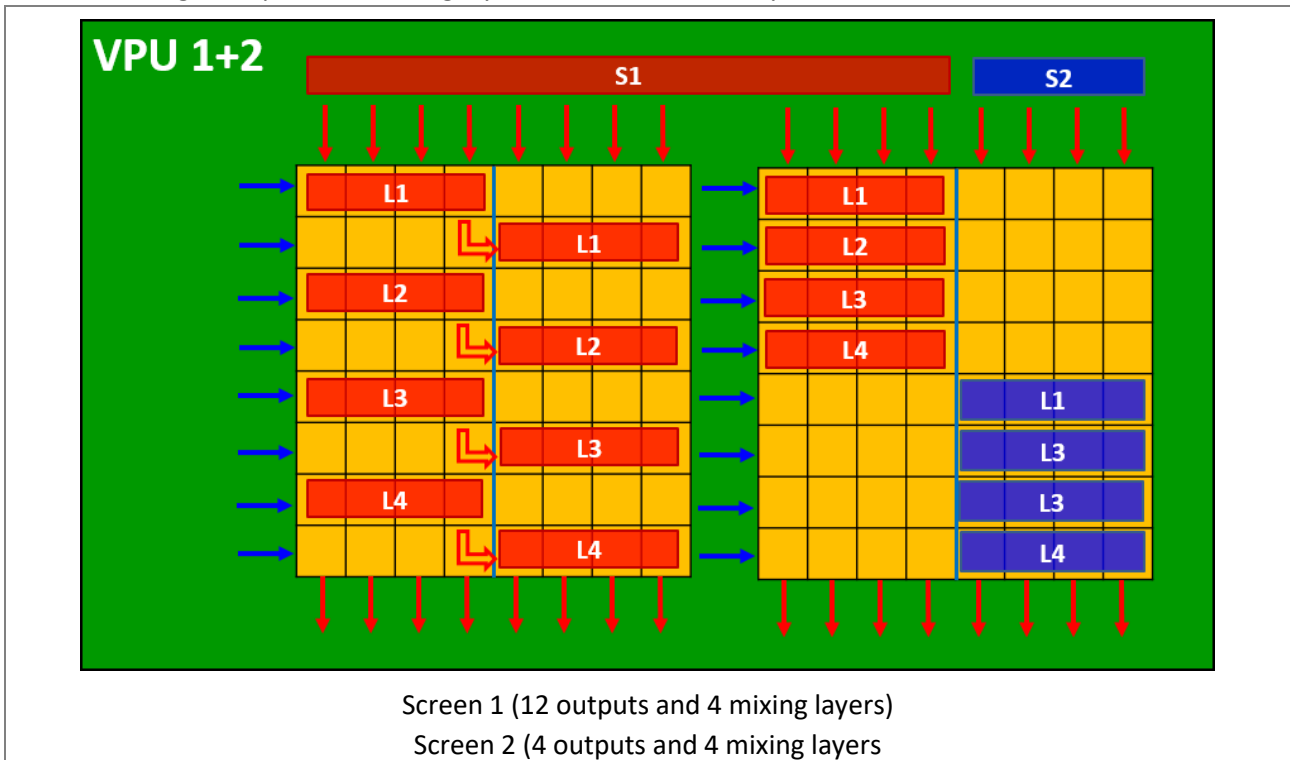

6.4.6 Optimized mode

An Optimized mode is enabled for the whole VPU when one Screen uses at least 5 outputs links and at least one layer of capacity 2. The Optimized mode removes the 4 links boundary and configures the links to bring the best performance for layers of capacity 2.

Recommendation: When Optimized mode is enabled in one Screen, use only layers of capacity 2.

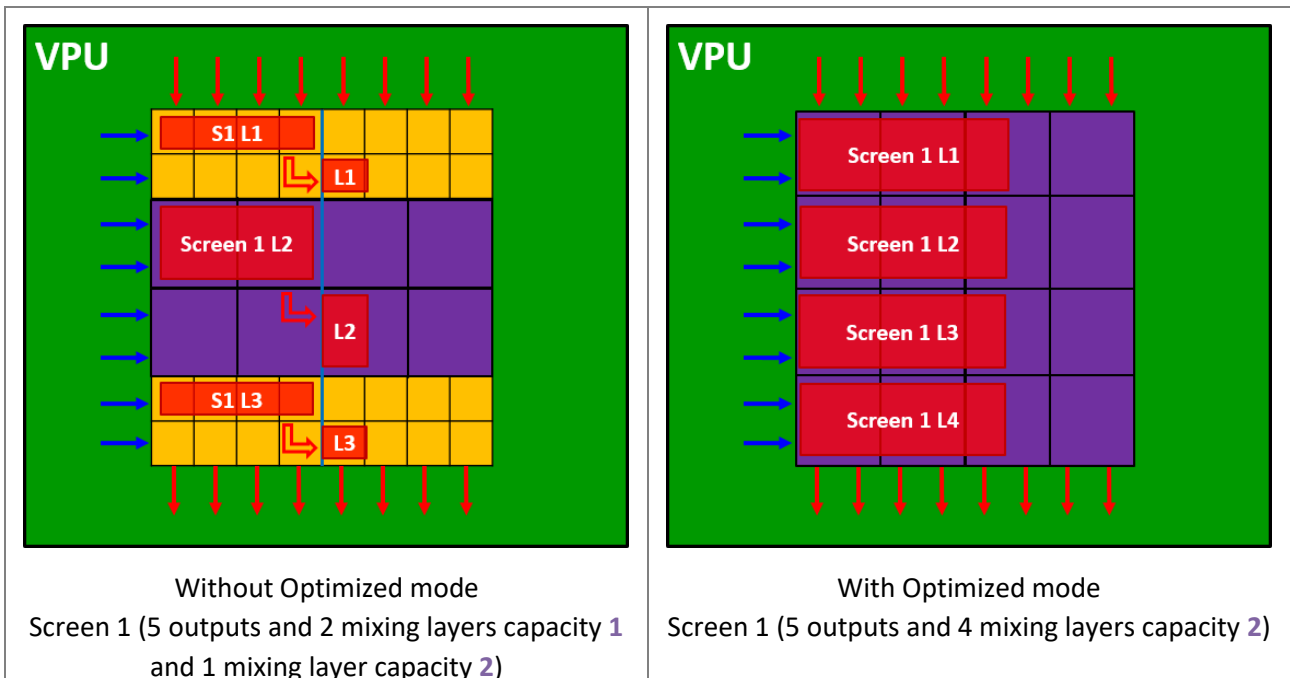

6.4.7 Cut & Fill resources

The Cut & Fill effect is enabled for a layer and doubles the resources needed for that layer.

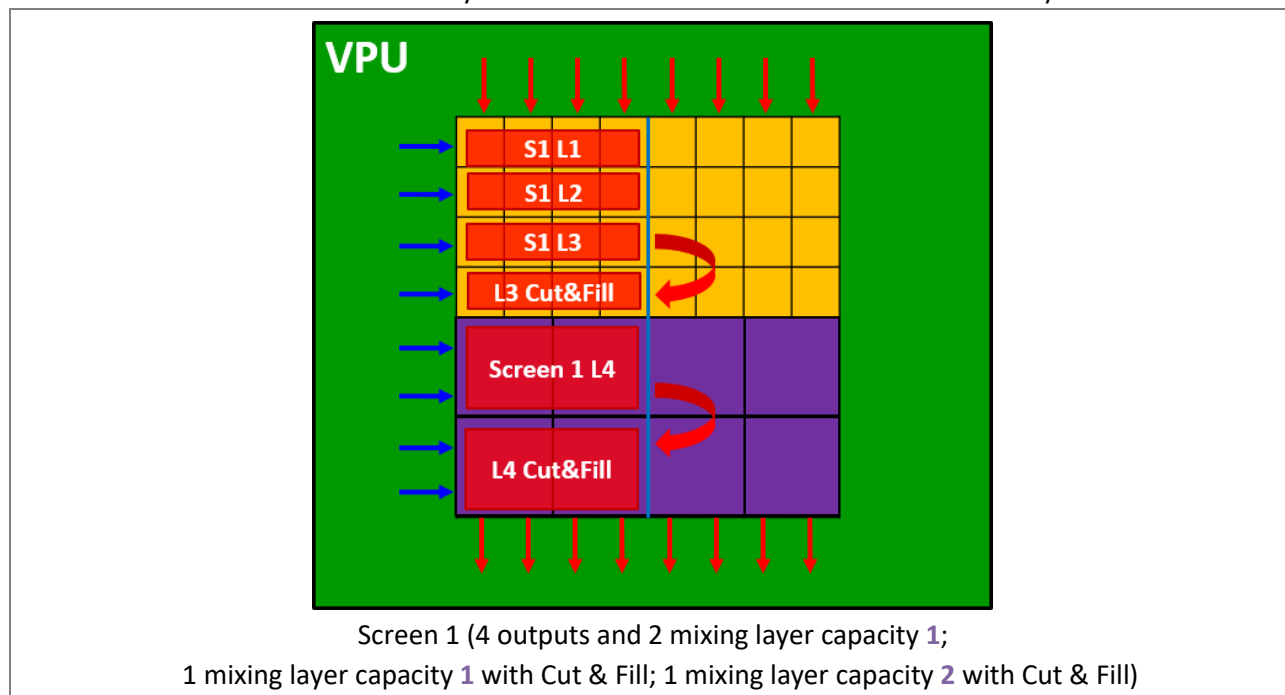

6.4.8 How many VPUs per model?

LivePremier units are equipped with up to 3 VPUs.

Aquilon Models	RS alpha	RS1	RS2	RS3	RS4	C	C+
VPUs	1	1	2	2	3	up to 2	up to 3
Output connectors	4	8	12	12	16	up to 16	up to 20
Max 4K60 PGM outputs (capacity 2)	4 Screens + 0 Aux	4 Screens + 4 Aux	8 Screens + 4 Aux	8 Screens + 4 Aux	12 Screens + 4 Aux	8 Screens + 8 Aux	12 Screens + 8 Aux
Max 4K60 mixing layers (capacity 2)	4	4	8	8	12	up to 8	up to 12
Max DL split layers (capacity 1)	16	16	32	32	48	up to 32	up to 48

Note: VPUs are automatically joined together just like scaling engines depending on the Screen configuration.

6.4.9 IPUs

VPUs create video content for layers while image content is created by Image Processing cards (IPUs).

One IPU supports:

- up to 24 simultaneous images of capacity 1 displayed on Program.
- up to 12 simultaneous images of capacity 2 displayed on Program.

Note: - Images of capacity 1 and 2 can be displayed at the same time.

- When an image slot is set to capacity 2, it uses the resources of the next preset and preempts it.

Aquilon Models	RS alpha	RS1	RS2	RS3	RS4	C	C+
IPUs	1	1	1	2	2	0 or 1	Up to 2
Simult. 4K image channels	12	12	12	24	24	0 or 12	Up to 24

6.5 HDR conversion

Tip: HDR conversion adds no latency.

LivePremier can manage inputs and outputs with different frame rates. In the same way, LivePremier can also manage inputs and outputs with different dynamic range profiles, including Standard Dynamic Range (SDR) and High Dynamic Range (HDR).

HDR conversion manages:

- SDR ↔ HDR10
- SDR ↔ HLG
- HDR10 ↔ HLG

The LivePremier processing engine supports HDR10 and HLG standards. SDR to HLG conversion is based on professional 3D lookup tables (LUTs) by BBC.

The user can define an internal HDR profile and all inputs will be automatically converted for optimized processing and display. HDR conversion can also be manually set for each image slot, input and output.

Note: - HDR conversion means all content can be converted to be mixed and displayed perfectly. This does not mean SDR content will look better when converted to HDR.

- For more information, see the White paper explaining HDR conversion available on www.analogway.com.

6.6 LivePremier latency

The LivePremier series has been optimized to offer extremely low latency, in most cases between 1 and 2 frames.

Note: For more information, see the White paper (Training & Support) explaining LivePremier latency available on www.analogway.com.

7 Preconfig Menu

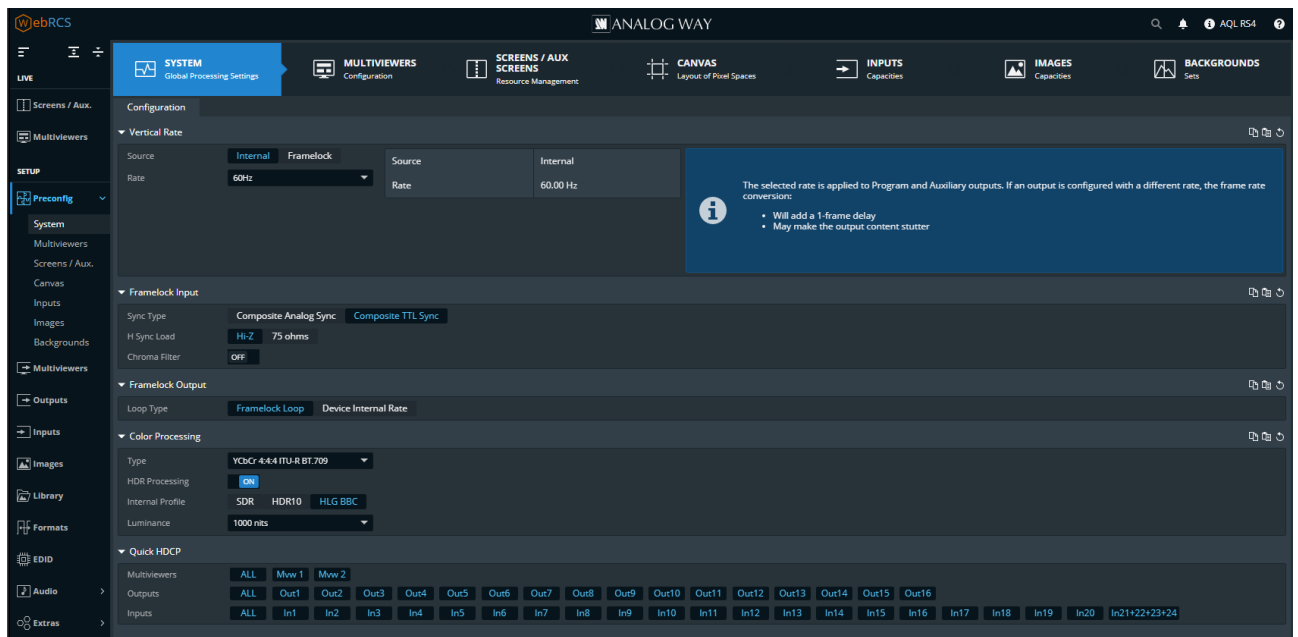

Fig. 12 - Preconfig Menu



Preconfig is composed of the following submenus:

- System
- Multiviewers quantity (one or two)
- Screens / Aux Screens
- Canvas
- Inputs
- Images
- Backgrounds



Click **Preconfig** to display the submenus.

7.1 Preconfig > System



In **Preconfig > System**, set internal rate, framelock, color space and quick HDCP.

7.1.1 Vertical rate

Vertical rate sets the overall internal operating frame rate of the unit, which defines the frame rate of all Program outputs. Vertical rate can be set manually, or by following a Genlock or Framelock as a reference.

Caution: If the Internal rate is set above 60Hz, some output formats and image resolutions may not be supported; and input resolutions beyond 2560x1600 will not be supported no matter the frame rate.

Tip: Using Framelock is useful to eliminate the “tearing effect” which may be visible as an artifact of the framelocking process.

7.1.1.1 Set defined rate

1. Go to  **Preconfig** > System.
2. In **Vertical Rate** > **Source**, click **Internal**.
3. In **Rate**, select the refresh rate.

7.1.1.2 Set relative rate

Caution: Make sure the reference input is a reliable source. Any disruptions in the reference signal may cause visible glitches on the output, even if the selected framelock reference input is not being displayed.

1. Go to  **Preconfig** > System.
2. In **Vertical Rate** > **Source**, click **Framelock**.
3. In **Reference**, select Genlock or the Input to be the refresh rate reference.
4. In **Factor**, select **x0.5** ; **x1** or **x2**. (the “reference rate x rate factor” must be between 22Hz and 120Hz).

7.1.2 Framelock input settings

These settings are applied when Framelock is set as Vertical rate.

Set the framelock sync settings according to your video sync setup.

Setting name	Description / Setting selection
Sync Type	Composite Analog Sync or Composite TTL Sync
H sync Load	Hi-Z or 75 ohms
Chroma Filter	On/Off toggle. Filter the chroma for better synchronization when using a composite video signal as framelock input.

7.1.3 Framelock output settings

Set the Framelock output to Loop the Framelock or to output the internal rate of the unit.

7.1.4 Color processing

Set the color space used for processing and set HDR processing.

Tip: **BT.709** is recommended for HD and **BT.2020** is recommended for 4K / UHD.

1. Go to  **Preconfig** > System.
2. In **Color Processing** > **Type**, select the general color space used for processing

Setting name	Description / Setting selection
Type	Select the general color space used for processing: <ul style="list-style-type: none"> • YCbCr 4:4:4 ITU-R BT.709, or BT.709 Limited range • YCbCr 4:4:4 ITU-R BT.2020, or BT.2020 Limited range
HDR Processing	On/Off toggle. Enable Dynamic range conversion.
Internal Profile	Select the Dynamic range used for processing.
Luminance	Select the nit level used for processing.

Note: The output color space is set per output in the Output menu. For more information, see 9 *Outputs* page 68.

7.1.5 Quick HDCP

From **Preconfig** > System, quickly enable / disable HDCP for all inputs and outputs in the same page.

Note: Disabling HDCP reduces possible problems when the content is not fully HDCP compliant. When output HDCP is disabled, HDCP inputs will not be displayed anymore.



1. Go to  **Preconfig** > System, in **Quick HDCP**.
2. In **Output Auto Mode**, set the mode for all outputs to **HDCP 1.x First** or **HDCP2.x First**.
3. In **Multiviewers, Outputs** and **Inputs**, select a connector to enable / disable HDCP.
The connectors highlighted in **Blue** are currently enabled.
4. In **Input Default Mode**, set the mode for all inputs to **HDCP 1.x Only** or **HDCP 1.x and 2.x**.

7.2 Preconfig > Multiviewers

7.2.1 Multiviewers quantity

A Multiviewer is a dedicated output displaying a user customizable selection of Widgets as display resources. A Widget is an element containing a program, preview, input or image. One Multiviewer can display up to 64 Widgets.

A LivePremier unit can use One Multiviewer (64 Widgets in total) or Two Multiviewers (128 Widgets in total).

In  **Preconfig** >  Multiviewers, choose to enable the Multiviewer mode.

Two Multiviewers	- Max output resolution per Multiviewer is 2560x1600@60 or 4K@30 - Up to 128 widgets
One Multiviewer	- Max output resolution is 4K@60 - Up to 64 widgets - Can be duplicated on the second Multiviewer plug



Note: - By default, Two Multiviewers are enabled.

- In case of duplication, *Group Format* and *Group Adjustment* settings changed on one Output is also applied to the other output.

- After making changes, click **Apply** to save the new configuration.

7.2.2 Set a DPH104 for a Multiviewer DP output

A LivePremier device can be equipped with two DisplayPort 1.2 Multiviewers outputs instead of HDMI 2.0.

1. In  **Preconfig** >  Multiviewers, choose to enable **One Multiviewer** or **Two Multiviewers screens**.
2. In **DPH104 2x2 Slicer Mode**, toggle on to enable the 2x2 Slicer Mode for the corresponding Multiviewer output.
3. In  **Multiviewers**, set the format applied to every output of the DPH104.

Note: The output resolutions supported by the DPH104 are 4x 1600x1200; 4x 1920x1080 and 4x 1920x1200.

7.3 Preconfig > Screens / Aux Screens

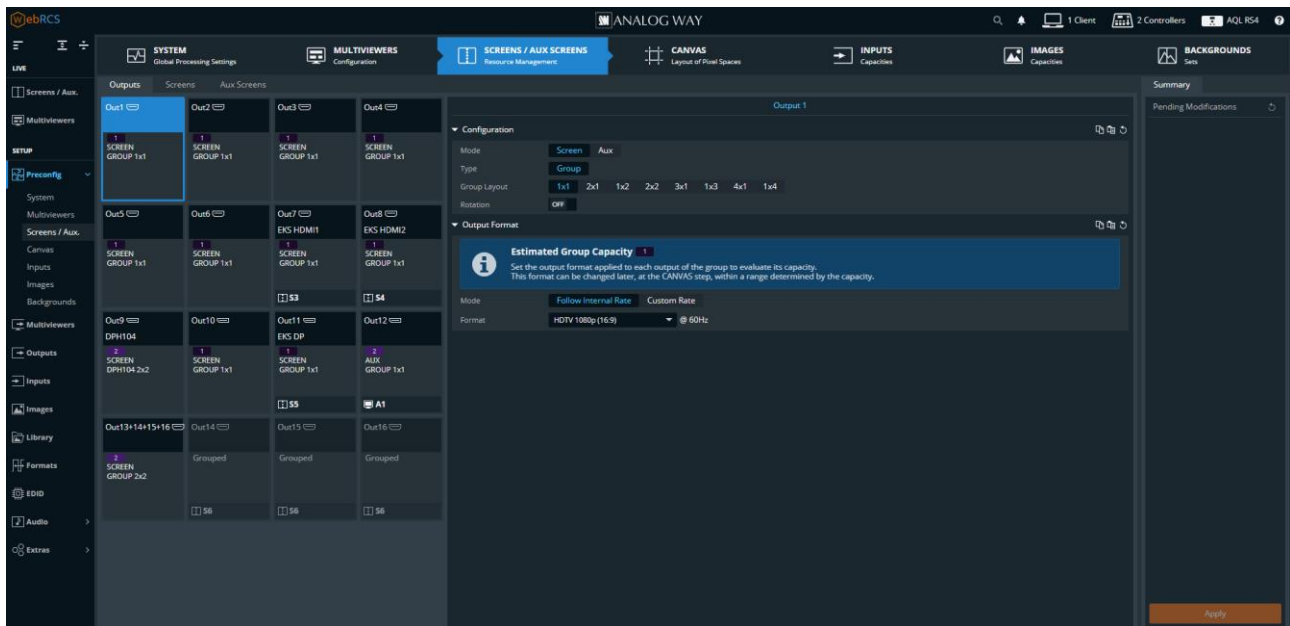





Fig. 13 - Preconfig – Screens / Aux Screens

In  **Preconfig** >  Screens / Aux Screens:

- Set output groups, output rotation and output group format
- Set a DisplayPort output as using a DPH104
- Enable Screens and assign outputs to Screens (and Aux Screens)
- Set Screen Layer mode (Mixing or Split)
- Set the layers quantity and capacity (1/2; Cut & Fill)

Note: - Output rotation is enabled in  Preconfig >  Screens / Aux Screens and then set in  Preconfig >  Canvas.

- The Cut & Fill effect is set for a layer (or pair of split layers) during the layer allocation as it requires VPU resources.
- After making changes, click **Apply** to save the new configuration.

7.3.1 Output group

Output group optimizes the resources of the VPU when using Screens with multiple outputs. This allows using more outputs in the same VPU (ex: one VPU can then manage up to 16 outputs in four 2x2 Screens).

It is also possible to set a 4K image or live input as a background content for an output group composed of four HDTV outputs. With output groups, the content used in background does not need to be divided beforehand as this is performed by the LivePremier unit.

Note: - It is possible to group up to four outputs together.
 - When grouped together, every output must have the same format and the group bandwidth is limited to capacity 2 (total pixel space is limited to 4096x2160).

Grouping outputs optimizes the processing resources and grants more possibilities for VPUs. An output can only be grouped with the following output in the same output card. The group leader is always the output with the lowest number (ex: If output 7 and 8 are grouped together, then output 7 is the leader and output 8 is set as *Grouped*).

Output group examples: one output at 3840x2160; two outputs at 4096x1080; or four at 1920x1080, etc.

Note: - By default, all outputs are set in a 1x1 group.
 - Rotation is possible for the output group but not for independent outputs inside groups.
 - Individual output settings are still available in the Output menu (color space, patterns, HDCP, audio channels, etc.).
 - Using a group of two or more outputs adds a one frame latency.



7.3.2 Output capacity – The 4-4 rule

A LivePremier unit is equipped with one, two or three Video Processing cards (VPU). Output resources are impacted by format (resolution and rate). LivePremier units have a limited number of Program outputs depending on the capacity set for these outputs.

Tip: - One VPU supports **4x** capacity 2 program outputs AND **4x** capacity 2 mixing layers
 - The remaining outputs that are not used as Program can be used as Aux.

Aquilon Models	RS alpha	RS1	RS2	RS3	RS4	C	C+
VPUs	1	1	2	2	3	up to 2	up to 3
Output connectors	4	8	12	12	16	up to 16	up to 20
Max 4K60 PGM outputs (capacity 2)	4 Screens + 0 Aux	4 Screens + 4 Aux	8 Screens + 4 Aux	8 Screens + 4 Aux	12 Screens + 4 Aux	8 Screens + 8 Aux	12 Screens + 8 Aux
Max 4K60 mixing layers (capacity 2)	4	4	8	8	12	up to 8	up to 12
Max DL split layers (capacity 1)	16	16	32	32	48	up to 32	up to 48

7.3.3 Set an output group for a Screen

1. In  **Preconfig** >  Screens / Aux Screens > Outputs tab, click an output.
2. In **Configuration**, select **Screen** mode and **Group** type.
3. Select the output group layout (**1x1** by default).
Selecting a higher group layout automatically groups the following output(s).
4. If needed, enable rotation for the output group.
5. In **Group Format**, set the format applied to every output of the group.

Tip: Capacities are automatically assigned when setting a format.

Note: - Using a group of two or more outputs adds a one frame latency.

- Enabling output rotation adds a one frame latency.

- Using both rotation and multi-output group at the same time only adds one frame latency.



- Enabling output rotation for a 1x1 output with capacity 2 disables the next output plug.

For more information on output rotation, see 7.4.2 *Set output rotation* page 56.

7.3.4 Set a DPH104 output for a Screen



Tip: If the internal rate is set to 30Hz or less, an output with a DPH104 is set to capacity 1.

This means an Aquilon C+ with 20 DPH104 can feed up to 80 1920x1080@30 displays.

1. In  **Preconfig** >  Screens / Aux Screens > Outputs tab, click a DisplayPort output connected to a DPH104.
2. In **Configuration**, select **Screen** mode and **DPH104 Slicer** type.
3. Select the Layout (**4x1; 2x2 or 1x4**).
4. If needed, enable rotation for every output of the DPH104.
5. In **DPH104 Format**, set the format applied to every output of the DPH104.

Note: The output resolutions supported by the DPH104 are 4x 1600x1200; 4x 1920x1080 and 4x 1920x1200.



7.3.5 Set an output for an Aux Screen

1. In  **Preconfig** >  Screens / Aux Screens > Outputs tab, click an output.
2. In **Configuration**, select **Aux** mode.
3. Select the Layer quantity (**2** by default).
Selecting a higher layer quantity automatically preempts the following output(s).
4. In **Group Format**, set the format applied to the output.

7.3.6 Aux output duplication

When an output is set to Aux mode with 4 or more layers, the following output(s) are preempted. These outputs become disabled by default, but they can be set to duplicate the content of the preempting Aux output.

Note: In case of duplication, *Group Format* and *Group Adjustment* settings changed on one Output is also applied to the other output.

1. In  **Preconfig** >  Screens / Aux Screens > Outputs tab.
2. Set an output to **Aux** mode with 4 or more layers.
The next output(s) are disabled.
3. In Output Duplication, toggle **Allow on Output X** to enable the duplication.

Tip: It is also possible to enable/disable the duplication when selecting the target output.

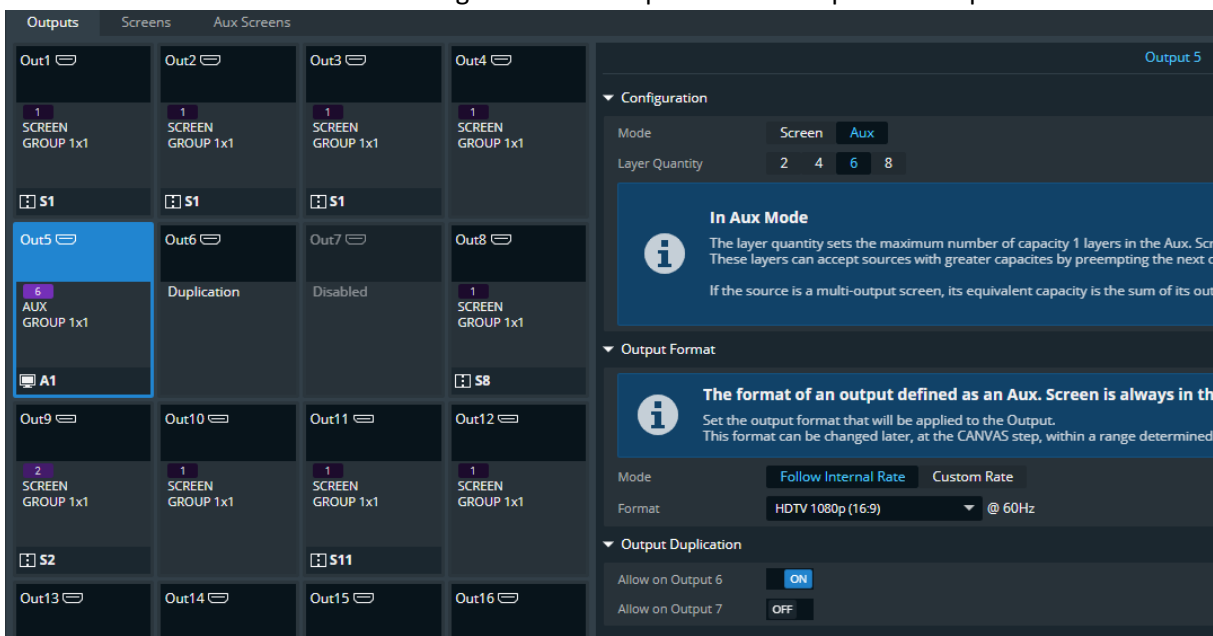

The content of the Aux will be sent through the main output and the output with duplication enabled.





The screenshot displays the 'Outputs' configuration page. On the left, a grid of 16 output cards is shown. 'Out5' is selected and highlighted in blue, showing it is in 'AUX GROUP 1x1' mode with 6 layers. 'Out6' is labeled 'Duplication', 'Out7' is 'Disabled', and 'Out8' is 'SCREEN GROUP 1x1'. Other outputs are in 'SCREEN GROUP 1x1' mode with 1 or 2 layers. On the right, the configuration panel for 'Output 5' is visible. Under 'Configuration', 'Mode' is set to 'Aux' and 'Layer Quantity' is set to 6. A blue information box titled 'In Aux Mode' explains that the layer quantity sets the maximum number of capacity 1 layers in the Aux. Screen. Under 'Output Format', 'Mode' is set to 'Follow Internal Rate' and 'Format' is 'HDTV 1080p (16:9) @ 60Hz'. Under 'Output Duplication', 'Allow on Output 6' is set to 'ON' and 'Allow on Output 7' is set to 'OFF'.

Fig. 14 - Aux output duplication

7.3.7 Create a Screen

In  **Preconfig** >  Screens / Aux Screens > Screens tab, click a Screen to show more options:

Note: An output group must be set to **Screen** mode to be assigned in a Screen.

- Enable/disable the Screen
- Select the Layer mode (Mixing layers or Split layers)
- Use drag and drop to assign Output groups to a Screen.
- Use  to unassign an Output group.
- In **Layers**, use the **Add layer** and  buttons to set the Layer quantity.
- Click **Apply** to save new configuration.

The number of remaining layers is indicated, it depends on layers capacity and the use of Cut & Fill .

Note: For more information about using Cut & Fill, see [14.2.4 Cut & Fill effect](#) page 98.

Tip: - All pending changes are identified with a * and listed in the Summary. If needed, click  to cancel pending changes.
 - It is possible to modify layers capacity after creation without removing all layers.
 - The Optimized notifier shows when the Optimized mode is enabled. For more information see [6.4.6 Optimized mode](#) page 44.

7.3.8 Create an Aux Screen

In  **Preconfig** >  Screens / Aux Screens > Aux Screens tab, click an **Aux Screen** to show more options.

Note: An output must be set to **Aux** mode to be assigned to an Aux Screen.

- Use drag and drop to assign one Output to an Aux Screen.

The Layer quantity indicated depends on the capacity set in the Outputs tab.

- Use  to unassign the Output.

Note: - After making changes, click **Apply** to save the new configuration.



- The number of Aux layers depends on the output capacity and the bandwidth of the content used in the layers. For more information, see [6.3 Aux Screens and Aux layers](#) page 40.

Tip: All pending changes are identified with a * and listed in the Summary. If needed, click  to cancel pending changes.



7.3.9 Rename a Screen

By default, all Screens are named S1, S2, or A1, A2 and so on.

To rename a Screen:

1. In  **Preconfig** >  Screens / Aux Screens, click a Screen or Aux Screen on **Enter Label...**
2. Enter a screen name.

7.4 Preconfig > Canvas

In  **Preconfig** >  **Canvas**, set the pixel space and the outputs settings for each screen (custom rate, position, rotation, AOI, pitch size, blending, etc.).

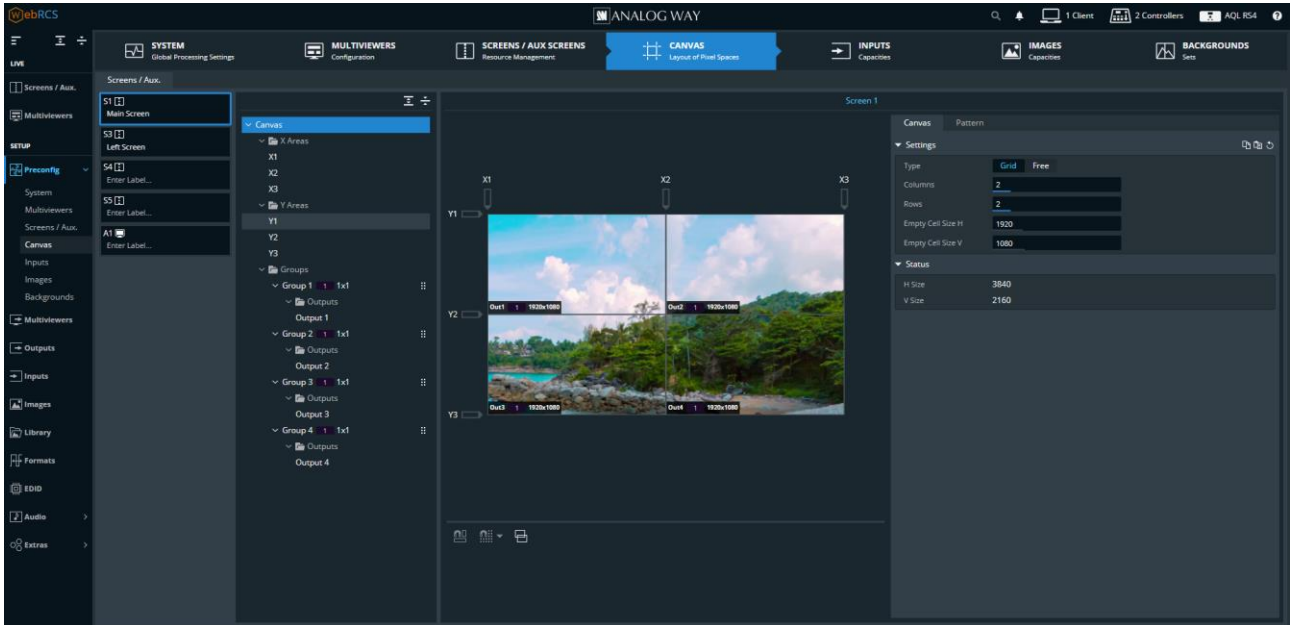

Fig. 15 - Preconfig - Canvas

By default, all output groups are stacked and the screen size is the same as the assigned output group with the highest resolution.

The Screen canvas are separated in two types:



Grid type	Recommended for standard shows (a single output screen, a screen with identical displays aligned horizontally or vertically, 2x2, etc.). Covering and gap are simplified in Grid with the X and Y areas.
Free type	Recommended for more specific shows that require manual adjustments for each output. Covering is set manually for each output.

Note: - Free type is selected by default.

- Canvas settings are applied to the selected Screen or Group.

- Grid and Free type have their own settings and switching between types does not keep the current configuration.

7.4.1 Tree view

In  **Preconfig** >  Canvas, select a Screen to display the tree view of the Screen. Select one element to change the corresponding settings in the right panel.

X and Y areas	(Only displayed if the Screen is in Grid type) Create covering or gap between the grid cells. Set blending and black areas for covering areas.
Groups and DPH104s	Set the position of the output groups (or DPH104) in the Screen canvas. Set the format set a format every output in the group (or DPH104). Group Pattern, display patterns to identify the outputs.
Outputs	Set the position of the output in the output group. Set an AOI for the output.

Tip: - In Grid mode, the  icon identifies groups and outputs which can be dragged in the cells of the canvas.





- The  icon identifies groups which have rotation enabled. The rotation is set in the right panel.

Note: - Outputs are placed in groups. And groups are placed in Screens.

- An output group fits in one Screen Grid cell. A 2x2 output group fits in a 1x1 Screen Grid.

7.4.2 Set output rotation

Output rotation is enabled in  Screens / Aux Screens, Outputs and set in  Canvas.

1. In  **Preconfig** >  Screens / Aux Screens, Outputs, select an output group.
2. In Configuration, enable the output **Rotation**, then assign the output to a Screen and apply the configuration.
3. In  Canvas, select the Screen.
4. In the tree view, select the output group (identified with ).
The output group settings are displayed in the right panel.
5. In Rotation, set the rotation angle (**None**, **90°**, **180°** or **270°** counterclockwise).

Output rotation is set for the output group.

Note: - Enabling output rotation in Preconfig / Screens / Aux Screens adds a one frame latency.

- Enabling output rotation for a 1x1 output with capacity 2 disables the next output plug.

Note: When using output rotation on a group, rotation is set individually with each output staying in its position.

Tip: - If the physical displays are rotated at 90° clockwise, set the output group rotation at 90°.
 - It is possible to reassign an output to another cell in the virtual canvas.



Output rotation	Display result
No rotation or 180° rotation	
90° rotation CCW or 270° rotation CCW	

Fig. 16 - Display result using output rotation - 2x2 Screen

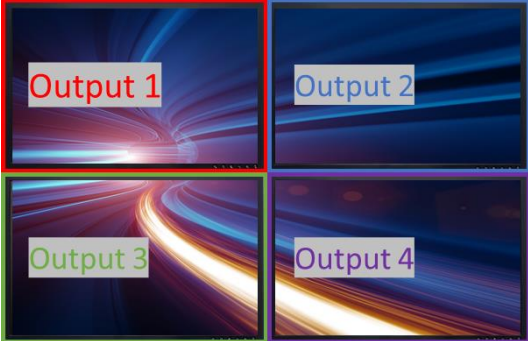

Output rotation	Display result
No rotation or 180°	
90° or 270°	

Fig. 17 - Display result using output rotation – 3x1 Screen

7.4.3 Patterns

Display patterns are used during the Screen configuration phase to test and control how outputs are displayed in Screens. Use patterns to identify and test that the displays are set correctly (color, position, resolution, etc.). Enabling a pattern overrides any content displayed in the output. It is possible to use Screen patterns and Output patterns.

Tip: Make sure to keep all patterns disabled when they are not needed.

Note: Screen patterns are displayed on top of Output patterns.

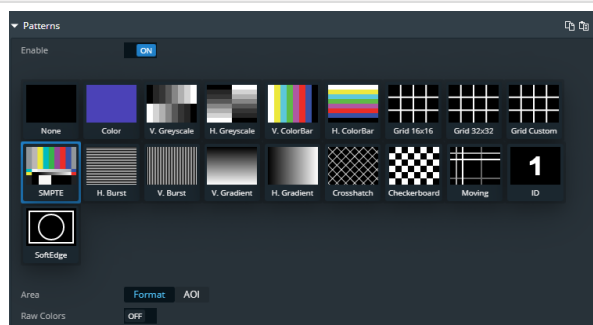
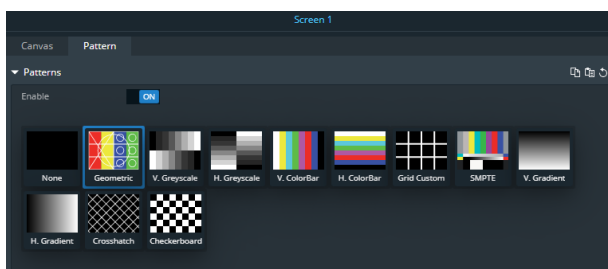

Fig. 18 - Screen patterns / Output patterns

7.4.3.1 Screen pattern

Use Screen patterns to apply one pattern on the entire screen.

Setting name	Description / Setting selection
Patterns	
Enable	On/Off toggle. Display the pattern in the Screen
Patterns	Select the pattern to display

Tip: - Make sure to keep all patterns disabled when they are not needed.

- The pattern *Geometric* is fully customizable to adapt to any screen.
- The patterns *Grid Custom*, *Crosshatch* and *Checkerboard* are customizable patterns with units in pixels.

7.4.3.2 Output pattern

Use Output patterns to test and control how outputs are displayed in Screens.

Setting name	Description / Setting selection
Patterns	
Enable	On/Off toggle. Display the pattern in output
Patterns	Select the pattern to display
Area	Set the pattern to fit the format used or the AOI
Raw Colors	On/Off toggle. Using raw colors disables all Adjustments settings (ex: Colorimetry, User Gain, etc.)
Raster Box	
Format	Click to enable raster box on whole format
AOI	Click to enable raster box on AOI



Tip: - Remember to enable and disable patterns on all outputs.

- The patterns *Grid Custom*, *Crosshatch* and *Checkerboard* are customizable patterns with units in pixels.

7.4.4 Grid canvas

7.4.4.1 Create a Grid canvas

In **Grid** type, create a grid and assign output groups to corresponding cells to create the Screen canvas.

1. In  **Preconfig** >  Canvas, select a Screen.
2. Select the **Grid** canvas type.
3. Enter the number of columns and rows for the Screen Grid.
4. If needed, enter the size for the empty cells of the grid (in pixels).

The canvas is updated with the corresponding values and the total Screen size is indicated.



5. In the Tree view, click an output group and use drag and drop to assign it to a grid cell in the canvas.
Or go to **Group Canvas** in the right panel and set its position using the Column and Row settings.
6. In **Group Format**, set a format for every output in the group.
7. In **Group Pattern**, display patterns to identify the outputs.
8. Repeat steps 5 to 7 for all outputs / output groups.

Note: An output group fits in one Screen Grid cell. A 2x2 output group fits in a 1x1 Screen Grid.

7.4.4.2 Create a covering in Grid canvas (blending)

Edge blending is a feature that gradually fades out the overlapping area from both projectors to create a seamless projection. For an effective blending, align the projected images so they are square with each other. In **Grid** type, use X and Y areas to create coverings between outputs.

Note: In Grid type, coverings are equals for all outputs of the same row / column.

1. In  **Preconfig** >  Canvas, select a Screen with **Grid** canvas type.
2. Select the X or Y area where the covering will be created.
3. In **Configuration**, select Covering and enter the size in pixels.



The canvas is updated with the corresponding values.

4. If needed, in **Blending Curve**, enable the blending and set the Gamma or Bezier curve.
5. If needed, set the black area and black levels.

7.4.4.3 Create a gap in Grid canvas (bezel)

In **Grid** type, use X and Y areas to create gaps between outputs.

Note: In Grid type, gaps are equals for all outputs of the same row / column.

1. In  **Preconfig** >  Canvas, select a Screen with **Grid** canvas type.
2. Select the X or Y area where the gap will be created.
3. In **Configuration**, select Gap and enter the size in pixels.

The canvas is updated with the corresponding values.

7.4.5 Free canvas

Free type is separated in two modes:



Auto mode	Set the position of each output or group freely. The canvas size is automatically computed and optimized for the created Screen.
Custom mode	Set the Screen size then position each output or group inside the created Screen.

7.4.5.1 Bottom bar buttons – Output position

In **Free** type, it is possible to use drag and drop in the virtual canvas to position the outputs.

Use the bottom buttons to help positioning outputs in the virtual canvas.

All bottom bar buttons are On/Off Toggle buttons.

Button	Button description
	Snap to Screen border and other outputs borders.
	Snap to grid cells. Click the arrow to set the grid (columns and rows).
	Hide content to display only layers wireframe.

7.4.5.2 Create a canvas in Auto mode

In **Auto** mode, select outputs and enter their H position and V position or use drag and drop to create the Screen canvas.

Auto mode is recommended for complex shows with unknown canvas size.

In  **Preconfig** >  Canvas, select a Screen.

1. Select the **Free** canvas type and **Auto** size mode.
2. In the tree view, select an output group.
3. Use drag and drop in the canvas to place the output group.
Or go to **Group Canvas** in the right panel and enter H and V position for the output group (in pixels).
4. In **Group Format**, set a format for every output in the group.
The canvas is updated with the resolution and position settings.
5. In **Group Pattern**, display patterns to identify the outputs.
6. Repeat steps 2 to 4 for all outputs / output groups.

Tip: Use the tools in the bottom bar to snap to a custom grid and/or other outputs.

7.4.5.3 Create a canvas in Custom mode

In **Custom** mode, enter a H and V size to create the custom Screen canvas. Then enter position or use drag and drop to position each output inside the canvas.

Custom mode is recommended for complex shows where the canvas size is known.

In  **Preconfig** >  Canvas, select a Screen.

1. Select the **Free** canvas type and **Custom** size mode.
2. Click **H Size** and **V Size** to enter canvas size.

The canvas size in the virtual screen is updated to match the settings.



3. In the tree view, select an output group.
4. Use drag and drop in the canvas to place the output group.
Or go to **Group Canvas** in the right panel and enter H and V position for the output group (in pixels).
5. In **Group Format**, set a format for every output in the group.
The canvas is updated with the resolution and position settings.
6. In **Group Pattern**, display patterns to identify the outputs.
7. Repeat steps 3 to 5 for all outputs / output groups.

Tip: Use the tools in the bottom bar to snap to a custom grid and/or other outputs.

7.4.5.4 Create a covering in Free canvas (blending)

Recommendation: only use manual blending in Free canvas for complex shows. If a blending is needed for a standard show (ex: 2x2 or 3x1 Screen configuration), it is recommended to use Grid canvas.

Edge blending is a feature that gradually fades out the overlapping area from both projectors to create a seamless projection. For an effective blending, align the projected images so they are square with each other.

1. In  **Preconfig** >  Canvas, select a Screen with **Free** canvas type.
2. Select an output where the covering will be created.
3. Go to **Areas** in the right panel and select a side of the output to apply covering.
4. In **Configuration**, enter the covering size in pixels.

The canvas is updated with the corresponding values.



5. If needed, in **Blending Curve**, enable the blending and set the Gamma or Bezier curve.
6. If needed, set the black area and black levels.
7. Repeat steps 2 to 6 for the side(s) of other the output(s).



7.4.6 Advanced output settings (in Preconfig > Canvas)

Note: Output settings are applied to the selected output.

These following settings are specific to outputs and can be used in all canvas types.

7.4.6.1 Canvas settings for DPH104

All DPH104 outputs are limited to a grid created according to the Layout selected in  **Preconfig** >  Screens / Aux Screens (4x1; 2x2 or 1x4).



1. In  **Preconfig** >  Canvas, select a Screen.
2. Select a Screen type and place the output groups in the Screen canvas.
3. If needed, set rotation for all the outputs of the DPH104.
4. If needed, change/swap the positions of the DPH104 outputs.

Note: When connecting the DPH104 outputs to multiple video projectors, the LivePremier Web RCS can set outputs overlap. However, blending adjustments must be set using the projectors.

7.4.6.2 Create an area of interest (AOI)

The AOI is a cropped area of the display in the output format. Use AOI to remove unseen or useless display areas and operate exclusively on the output area actually displayed.



The AOI can be set with Overscan size or Custom size.

5. In  **Preconfig** >  Canvas, select a Screen.
6. Select an output.
7. In AOI, click **Overscan** and set the overscan.
Or click **Custom** and set the size and position of the AOI.



Tip: Use arrows for fine adjustment.

7.4.6.3 Pitch compensation

Some Screens using multiple outputs can have outputs with different pitches, especially LED video walls. Using pitch compensation corrects the outputs with different pitches for a screen with homogeneous scaling.

1. In  **Preconfig** >  Canvas, select a Screen.
2. Select an output group to set a different pitch.
The reference output group should use a 1:1 pitch.
3. In Pitch, set the H and V ratio of the output group compared to the reference output group.

7.5 Preconfig > Inputs

In  **Preconfig** >  Inputs, set input group and input format.

7.5.1 Input group

Inputs can be grouped together to be used as one source content. Using input group saves time and frees layers for processing optimization more. For example: it is possible to group four live inputs (in 1x4, 2x2 or 4x1) and used them as one source in one layer.

Note: - It is possible to group up to four inputs together.

- All grouped inputs must be in the same input card.

- When grouped together, every input must have the same format and the group bandwidth is limited to capacity **2** (total pixel space is limited to 4096x2160).

- If the Internal rate is set above 60Hz, input resolutions beyond 2560x1600 will not be supported no matter the frame rate.

Input group saves layers in Screens and grants more possibilities for VPUs.



It is also possible to set a four HDTV live input as a background content for an 4K output group.

An input can only be grouped with the following input in the same output card. The group leader is always the input with the lowest number (ex: If input 7 and 8 are grouped together, then input 7 is the leader and input 8 is set as *Grouped*).

Note: - By default, all inputs are set in a 1x1 group.

- Input settings available in the input menu are common for all inputs in the group (color space, patterns, crop, keying, etc.).

7.5.2 Set an input group

1. In  **Preconfig** >  Inputs, select one or more inputs.
2. In **Configuration**, select the input group layout (**1x1** by default).
Selecting a higher group layout automatically groups the following input(s).
3. In **Expected Signal**, set the format applied to every input of the group.

Or click  to automatically fit to the detected signal.



The capacity is indicated for this input group.

Note: - An input group with capacity **2** can only be displayed in a layer with capacity **2**.

- An input group with capacity **2** uses 2 Aux layers (one layer will be preempted).



7.5.3 Set four 3G-SDI inputs for 2SI format

Tip: It is possible to connect the four 3G-SDI inputs in any order as long as they are connected to the same input card and the SDI signal is encoded in 2SI format.

1. Connect the four 3G-SDI on the same input connector card on the rear panel.
2. In  **Preconfig** >  Inputs, select the first SDI input of the group.
3. In **Configuration**, set the group layout to **2x2**.
4. In **Expected Signal**, set the format applied to every input of the group.

The content is automatically recomposed by the LivePremier device and the content is ready to be used as a single 4K source.

7.6 Preconfig > Images

In  **Preconfig** >  **Images**, set the expected image resolution for image slots.

7.6.1 Image slots



The number of available image slots displayed at the same time depends on the number of IPU of the unit and the image slots capacity.

Number of IPUs	Image slots available
1	24 image slots at capacity 1
	12 image slots at capacity 2
2	48 image slots at capacity 1
	24 image slots at capacity 2

Note: - Image slots of capacity **1** and **2** can be displayed at the same time.

- An image slot with capacity **2** uses the resources of the next slot and preempts it, no matter the real image resolution.
- An image slot with capacity **2** can only be displayed in a layer with capacity **2**.
- An image slot with capacity **2** uses 2 Aux layers (one layer will be preempted).
- For more information on LivePremier units and IPUs, see 6.4.9 IPUs, page 45.

7.6.2 Set images preset capacity



1. In  **Preconfig** >  **Images**, select one or more image slots.
2. In the right panel, set the expected image resolution for the image slot(s).

The capacity is indicated for this image slot.

Note: - An image capacity is set for the slot and stays the same when changing the image in the slot.

- If the Internal rate is set above 60Hz, some image resolutions may not be supported.

7.7 Preconfig > Backgrounds

In  **Preconfig** >  Backgrounds, create background sets for each Screen.

7.7.1 Background sets

Each Screen is composed of one or more output groups. Assign inputs and images to these output groups to create background sets. Up to eight Background sets can be saved per screen.

Note: - One input can be set as a background source for multiple outputs if they have the same format.

- Background sets can only be used in Screens.



- Aux Screens use a custom monochrome color as background (set in the layer properties in Live – Screens / Aux Screens).

7.7.2 Background set for a Screen with one output group

Note: The content and output capacities must match. Otherwise, it is not possible to assign it to the background set.

The procedure is the same if using one output or one output group with multiple outputs.

For example: Screen 1 is a single output screen using Output 1.



1. In  **Preconfig** >  Backgrounds, select **BS1** in **Screen 1**.
2. Click a source icon to open the Inputs or Images sources.
3. Drag a content and drop it in the virtual canvas or in Output 1.
Background set 1 is set and saved.

Repeat the procedure with BS2, BS3, etc. to create more Background Sets for Screen 1.

7.7.3 Background set for a Screen with multiple output groups



Note: The content and output capacities must match. Otherwise, it is not possible to assign it to the background set.

For example: Screen 2 is a 4x1 screen using Outputs 3, 4, 5 and 6, each output is a 1x1 output group.

1. In  **Preconfig** >  Backgrounds, select **BS1** in **Screen 2**.
2. Click a source icon to open the Inputs or Images sources.
3. Drag a content and drop it in the virtual canvas or in Output 3.
4. Repeat for other outputs.
Background set 1 is set and saved.



Repeat the procedure with BS2, BS3, etc. to create more Background Sets for Screen 2.

7.7.4 Reset a background set

1. In  **Preconfig** >  Backgrounds, select a Background Set.
2. Click  in the top right corner of the virtual canvas to clear the background set.

Tip: It is also possible to select each output and press the **Del** key to remove the assigned content one by one.

7.7.5 Remove a source from all background sets

1. In  **Preconfig** >  Backgrounds, click  in the top right corner of a source content.
2. Click **Remove from all BKG Sets**.

8 Multiviewers

A Multiviewer is an output displaying a user customizable selection of Widgets as display resources. A Widget is a Multiviewer layer containing a program, preview, input or image. One Multiviewer can display up to 64 Widgets.

In  **Multiviewers**, set the Label, Signal parameters, Patterns and Image correction.

Note: - Go to  Preconfig > Multiviewers to enable **One Multiviewer** or **Two Multiviewers screens**.

- Go to  Multiviewers to set the Multiviewers layout and Widgets.

8.1 Multiviewers settings

In  **Multiviewers**, click a Multiviewer output to open its settings. The selected output is highlighted in the interactive rear panel.

- In the header, rename the Multiviewer.
- On the interactive rear panel, hover over an output connector to display information about this output.
- On the interactive rear panel, click an output to open its settings.
- Click  to capture the video signal into an image file.

8.2 Multiviewer format

In  **Multiviewer**, select an output. In **Format**, the following settings are displayed:

Setting name	Description / Setting selection
Mode	Set to follow internal rate or select a custom rate in the list
Format	Set the format for the Multiviewer display

8.3 Multiviewers pattern

In  **Multiviewers**, select one Multiviewer. In **Pattern / Raster**, the following settings are displayed:

Setting name	Description / Setting selection
Patterns	
Enable	On/Off toggle. Display the pattern in Multiviewer
Patterns	Select the pattern to display
Area	Set the pattern to fit the format used or the AOI
Raw Colors	On/Off toggle. Using raw colors disables all Adjustments settings (ex: Colorimetry, User Gain, etc.)
Raster Box	
Format	Click to enable raster box on whole format
AOI	Click to enable raster box on AOI

Note: For more information on pattern types, see 7.4.3 *Patterns* page 58.

8.4 Multiviewers signal

In  **Multiviewers**, select one Multiviewer. In **Signal**, the following settings are displayed:

Setting name	Description / Setting selection
Pixel Encoding	Auto or RGB Full (8 or 10 bits), RGB Limited (8 or 10 bits), YCbCr 4:4:4 (8 or 10 bits), YCbCr 4:2:2 (12 bits), or YCbCr 4:2:0 (8 or 10 bits).
Color Space	Auto , ITU-R BT.709 , or ITU-R BT.2020
DVI mode	Enable to change HDMI signal into DVI signal if using a DVI connector on the Multiviewer display.
DDC Bus Speed	Slow , Medium or Fast (HDMI only)
HDCP	Disable* ; Auto ; HDCP 1.x ; or HDCP 2.x

**Disabling HDCP reduces possible problems when the content is not fully HDCP compliant. When output HDCP is disabled, HDCP-protected inputs are not displayed.*

Recommendation: Always use high quality cables to prevent connection and bandwidth errors when using HDCP.

Note: - The actual Pixel encoding and Color space used can be different from the one set in the output format. It is indicated in the details of the signal status in the table.

- DDC Bus Speed is set to **Fast** by default. Using **Slow** or **Medium** speed can be needed to resolve compatibility issue when using HDMI over fiber extenders.

8.5 Multiviewers adjustment (image correction)

In  **Multiviewers**, select one Multiviewer. In **Adjustments**, the following settings are displayed:

Setting name	Description / Setting selection
Brightness	Adjust Global, Red, Green and Blue for Brightness (Global and RGB are cumulative)
Contrast	Adjust Global, Red, Green and Blue for Contrast (Global and RGB are cumulative)
Colorimetry	Adjust Saturation and Hue
Temperature	Adjust Temperature
Gamma	Adjust Gamma level

9 Outputs

In  **Outputs**, set the Label, Signal parameters, Patterns and Image correction for each output group.

Note: - Go to  Preconfig >  Screens / Aux Screens > Outputs to set output resources.

- The thumbnail preview is only possible for Outputs used in Screens. Outputs used in Aux. Screens have a black thumbnail.

9.1 Outputs main screen

Go to  **Outputs**, the outputs main screen displays all outputs in a Grid view.

The following information are displayed per output:

- Resolution
- Format and rate (on hover)
- Output capacity
- Output number
- Output label
- Screen number using that output



9.2 Output settings

In  **Outputs**, click an output to open its settings. The selected output is highlighted in the interactive rear panel and all output information is listed next to the Output preview.

- Click **Outputs** to return to the outputs Grid.
- In the header, rename the selected output.
- On the interactive rear panel, hover over an output connector to display information about this output.
- On the interactive rear panel, click an output to open its settings.
- Click  to capture the Program output video signal into an image file.
- Click **Blink LED** to identify the selected output connector on the physical rear panel of the unit.

9.2.1 Output group format

In  **Outputs**, select an output. In **Group Format**, the following settings are displayed:

Note: Output format settings are identical for all outputs of the same group.

Setting name	Description / Setting selection
Format	
Mode	Set to follow internal rate or select a custom rate in the list
Format	Set the format for each output of the group
Configuration (only with DPH104)	OSD ON/Off toggle: Display / hide On Screen Display DPH104 information. Audio: - Select Mirror to send all 8 audio channels on all outputs. - Select Split to send audio channels 1&2 to DPH104 Output 1, audio channels 3&4 to DPH104 Output 2, and so on.
Phase Shift	Set Horizontal and Vertical offsets for each output of the group. The icon  indicates that an output group has a phase shift set.

9.2.2 Output group pattern

In  **Outputs**, select an output. In **Group Pattern**, the following settings are displayed:

Note: Output pattern settings are identical for all outputs of the same group.

Setting name	Description / Setting selection
Patterns	
Enable	On/Off toggle. Display the pattern in all outputs of the group
Patterns	Select the pattern to display
Area	Set the pattern to fit the format used or the AOI
Raw Colors	On/Off toggle. Using raw colors disables all Adjustments settings (ex: Colorimetry, User Gain, etc.)

Setting name	Description / Setting selection
Raster Box	
Format	Click to enable raster box on whole format
AOI	Click to enable raster box on AOI

Note: For more information on pattern types, see 7.4.3 *Patterns* page 58.

9.2.3 Output signal

In  **Outputs**, select an output. In **Signal**, the following settings are displayed:

Setting name	Description / Setting selection
Settings	
Pixel Encoding	Auto or RGB Full (8 or 10 bits), RGB Limited (8 or 10 bits), YCbCr 4:4:4 (8 or 10 bits), YCbCr 4:2:2 (12 bits), or YCbCr 4:2:0 (8 or 10 bits).
Color Space	Auto , ITU-R BT.709 , or ITU-R BT.2020
SDI Mapping	Auto , Quad Link Four Quadrants or Quad Link 2SI
SDI 3G Standard	Level A or Level B (SDI output only)
DVI mode	Enable to change signal into DVI signal if using a DVI connector on the display
DDC Bus Speed	Slow , Medium or Fast (HDMI only)
HDCP	Disable* ; Auto ; HDCP 1.x ; or HDCP 2.x

**Disabling HDCP reduces possible problems when the content is not fully HDCP compliant. When output HDCP is disabled, HDCP-protected inputs are not displayed.*

Recommendation: Always use high quality cables to prevent connection and bandwidth errors when using HDCP.

Note: - The actual Pixel encoding and Color space used can be different from the one set in the output format. It is indicated in the details of the signal status in the table.

- DDC Bus Speed is set to **Fast** by default. Using **Slow** or **Medium** speed can be needed to resolve compatibility issue when using HDMI over fiber extenders.

Setting name	Description / Setting selection
HDR Processing (only if HDR Processing is enabled in Preconfig > System)	
Output Profile	Select the Dynamic range used for this output (Auto , SDR , HDR10 or HLG BBC)
Luminance	Select the nit level used for this output
BBC Mapping	(only for HLG BBC with SDR as internal profile) Inverse Tone Mapping or Direct Mapping - Use Inverse Tone Mapping if internal processing and main output are using Limited Range color space.
BBC Reference	(only for HLG BBC ↔ SDR conversion) Scene Referred or Display Referred - Use Scene Referred for camera content. - Use Display Referred for computer content.
BBC OETF	(only for Scene Referred) Square Root or Strict

9.2.4 Output adjustment (image correction)

In  **Outputs**, select an output. In **Adjustments**, the following settings are displayed:

Setting name	Description / Setting selection
Brightness	Adjust Global, Red, Green and Blue for Brightness (Global and RGB are cumulative)
Contrast	Adjust Global, Red, Green and Blue for Contrast (Global and RGB are cumulative)
Colorimetry	Adjust Saturation and Hue
Temperature	Adjust Temperature
Gamma	Adjust Gamma level

10 Inputs

In  **Inputs**, set the Label, Signal parameters, Patterns, Image correction, Aspect and Keying.

Note: - Go to  Preconfig >  Inputs to set input resources.
- Input settings are identical for all inputs of the same group.

10.1 Inputs main screen

In  **Inputs**, the inputs main screen displays all inputs in a Grid view.

The following information are displayed per input:

- Resolution
- Signal Type (on hover)
- Input capacity
- Input number
- Input label
- The tallies turn red and green if the input is used in a **Program** and/or **Preview** Screen ●●.

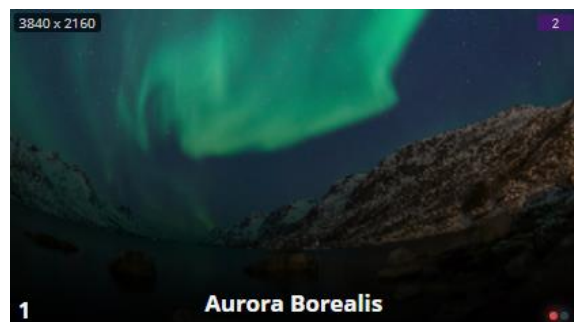

10.2 Input settings

In  **Inputs**, click an input to open its settings. The selected input is highlighted in the interactive rear panel and all input information is listed next to the input preview.

- Click **Inputs** to return to the inputs Grid.
- In the header, rename the selected input.
- On the interactive rear panel, hover over an input connector to display information about this input.
- On the interactive rear panel, click an input to open its settings.

General buttons are available on top of input settings:

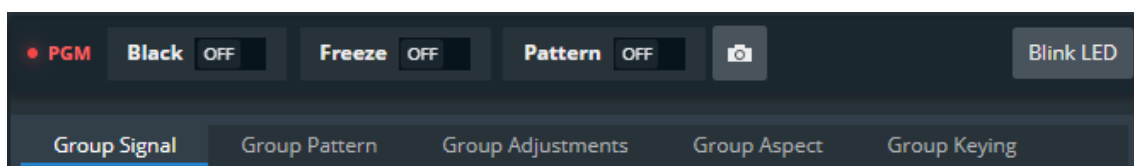



Fig. 19 - Input settings

- **PGM** turns red if the input is used in a Program screen.
- Toggle **Black** to display a black image in all layers using this input.
- Toggle **Freeze** to pause the content in all layers using this input (this does not pause the playback of a media).
- Toggle **Pattern** to replace the content with a pattern (see 10.2.2 *Input group pattern* page 73).
- Click  to capture the input video signal into an image file.
- Click **Blink LED** to identify the selected input connector on the physical rear panel of the unit.

10.2.1 Input group signal

In  **Inputs**, select an input. In **Group Signal**, the following settings are displayed:

Setting name	Description / Setting selection
Settings	
Signal Type	Auto , YUV , RGB Full (0-255) or RGB Limited (16-235).
HDCP	None* ; Default ; HDCP 1.x Only or HDCP 1.x and 2.x
SDI Mapping	Auto , Quad Link Four Quadrants or Quad Link 2SI
Control	
Black	On/Off toggle. Display Black in place of the selected input group.
Freeze	On/Off toggle. Freeze the input (useful for Color correction, Cropping or Keying).
HDR Processing (only if HDR Processing is enabled in Preconfig > System)	
Input Profile	Select the Dynamic range used for this input (Auto , SDR , HDR10 or HLG BBC)
Luminance	Select the nit level used for this input
BBC Mapping	(only for SDR with HLG BCC as internal profile) Inverse Tone Mapping or Direct Mapping - Use Inverse Tone Mapping if internal processing and main input are using Limited Range color space.
BBC Reference	(only for HLG BBC ↔ SDR conversion) Scene Referred or Display Referred - Use Scene Referred for camera content. - Use Display Referred for computer content.
BBC OETF	(only for Scene Referred) Square Root or Strict

**Disabling HDCP reduces possible problems when the content is not fully HDCP compliant. When input HDCP is disabled, HDCP-protected inputs are not displayed.*

Recommendation: Always use high quality cables to prevent connection and bandwidth errors when using HDCP.

10.2.2 Input group pattern

When enabled, a pattern overrides any input signal. Most patterns offer adjustment to isolate a particular color for easier troubleshooting and calibration.

In  **Inputs**, select an input. In **Group Pattern**, the following settings are displayed:

Setting name	Description / Setting selection
Patterns	
Enable	On/Off toggle. Display the pattern in input
Patterns	Select the pattern to display

Note: - A pattern applies to all inputs in the same input group.
- For more information on pattern types, see 7.4.3 *Patterns* page 58.

10.2.3 Input group adjustment (image correction)

In  **Inputs**, select an input. In **Group Adjustments**, the following settings are displayed:

Setting name	Description / Setting selection
Brightness	Adjust Global, Red, Green and Blue for Brightness (Global and RGB are cumulative)
Contrast	Adjust Global, Red, Green and Blue for Contrast (Global and RGB are cumulative)
Colorimetry	Adjust Saturation and Hue
Sharpness	Low, Medium or High

10.2.4 Input group aspect

In  **Inputs**, select an input. In **Group Aspect**, set the Aspect ratio or set input crop.

Note: Aspect ratio and Crop replaces the input content and affects every layer using it. If needed, use crop at layer level in Live or duplicate the input with a splitter.

10.2.4.1 Set input aspect ratio

Change the input aspect ratio in all layers. Use these settings to correct the input aspect ratio if needed.

Note: Change aspect ratio at layer level to keep the input unchanged.

Setting name	Description / Setting selection
Aspect Ratio	
Content ratio	Force an aspect ratio for the input if it needs correction (non-square pixels) (Native; 5:4; 4:3; 16:10; 15:9; 16:9; 21:9 or 64:27)
Transform to	Set the final aspect ratio for the input. This will be the native aspect ratio in the layer. (Native; 5:4; 4:3; 16:10; 15:9; 16:9; 21:9 or 64:27)
Layer fill option	1:1; Centered; Fullscreen or Cropped

10.2.4.2 Set input crop

Crop input (ex: black bars) and keep only wanted area in layers.

Setting name	Description / Setting selection
Crop	
Finder	On/Off toggle. Display cropping area in output, use during setup and disable Finder to show the crop result output.
Top, Bottom, Left, Right	Enter cropping values (in pixels)

Note: Input crop affects the whole group. Input crop is not possible for individual inputs inside a group.

10.2.5 Input Keying

In  **Inputs**, select an input. In **Group Keying**, key the content using Chroma Keying or Luma Keying.

- Use Chroma Keying to key a color (or hue).
- Use Luma Keying to key a Luma level (or brightness).

Note: Input keying applies to all inputs in the same input group.

10.2.5.1 Set Chroma Keying

1. In  **Inputs**, select one input and click Keying and **Chroma** mode.
2. Enable Freeze on the content.
3. In Value, select the Hue to Key (color).
4. Or use the assistant to pick directly from the content:
 - a. Enable the assistant.
 - b. Select the area to pick in the preview.
 - c. Click **Pick** to get the Hue value from the content.
 - d. Disable the assistant.
5. Enable the **Color** mask.
The content becomes blue, gray and red.
6. In Tolerance, adjust the settings until the Keying is correct:
The preserved content is displayed blue.
The keyed content is displayed red.
7. In Colorimetry, adjust the Color Correction to fade the selected hue.
8. Enable/Disable Freeze and Color mask to view the keying result and adjust settings until satisfied.

Note: The **Black and White** mask is similar with the preserved content displayed in white and the keyed content in black.



10.2.5.2 Set Luma Keying

1. In  **Inputs**, select one input and click Keying and **Luma** mode.
2. Enable Freeze on the content.
3. In Value, select the Luma to Key (Brightness level).
4. Or use the assistant to pick directly from the content:
 - a. Enable the assistant.
 - b. Select the area to pick in the preview.
 - c. Click **Pick** to get the Luma value from the content.
 - d. Disable the assistant.
5. Enable the **Color** mask.
The content becomes blue, gray and red.
6. In Tolerance, adjust the settings until the Keying is correct:
The preserved content is displayed blue.
The keyed content is displayed red.
7. Enable/Disable Freeze and Color mask to view the keying result and adjust settings until satisfied.

Note: The **Black and White** mask is similar with the preserved content displayed in white and the keyed content in black.

11 Images and Library

Image management is separated in two menus:



-  **Library:** transfer images to the LivePremier unit.
-  **Images:** assign uploaded image to image slot to be used in layers.

11.1 Library

Note: LivePremier units can store up to 200 images.

In  **Library**, all imported images are displayed in a Grid view.

The following information are displayed per image:

- Resolution
- Image recommended capacity
- Image number (in Library)
- Image file name
- Download to PC (hover then click )
- Delete from library (hover then click )



11.1.1 Image formats

LivePremier units support the following image formats:

- | | |
|----------------------|-------|
| - BMP | - PBM |
| - GIF (not animated) | - PGM |
| - JPG | - PPM |
| - PNG | - XBM |
| - SVG | - XPM |
| - TIF | |

Note: Animated images are not supported (ex: animated GIF)

11.1.2 Image specifications

- Maximum width: 16 384 pixels
- Maximum height: 8 192 pixels
- Maximum width x height: 8 847 360 pixels (= 4096x2160)
- Maximum file size: 35 MB

Note: Images cannot be resized or renamed in the Library. If needed, download the image, modify it and then re-upload it.

11.1.3 Transfer images from the computer to the unit

Note: It is possible to import only one folder at a time.

1. In  **Library**, select one or multiple image files (or a folder) on the computer file browser.
2. Drag and drop the selection in the **Drop images or folder of images** block.
3. Or click the block to open the file explorer and select image files to transfer.
The number of files to be imported is displayed.
4. Click **Upload Images**.

The selected images are imported in the Library and can be loaded into image slots.

11.1.4 Capture a video signal into an image file

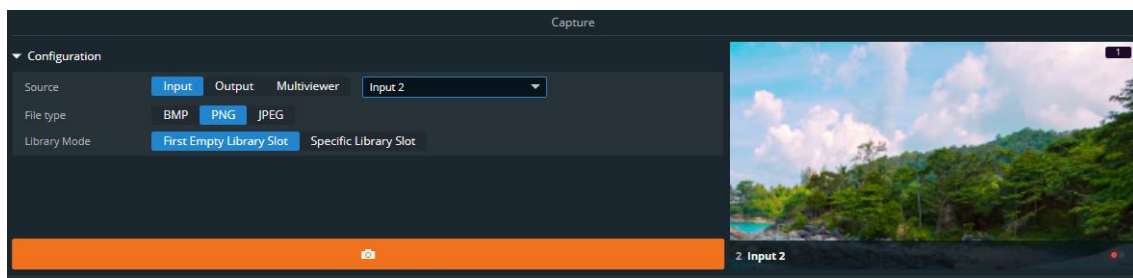





Fig. 20 - Capture a video signal into an image file

1. Go to  **Library** and configure the **Capture** settings.
 - a. In **Source**, select the source to capture (Input, Output or Multiviewer number).
 - b. In **File type**, select the image format for the capture (BMP, PNG or JPG).
 - c. In Library Mode, select to save the capture in the first empty slot or select a specific slot.
2. Click  to capture the video signal into an image file.

The image is created in the Library and can be loaded into image slots.



Tip: Image capture is also possible directly from the *Live, Multiviewers, Outputs and Inputs* pages.

11.1.5 Download an image file from the unit

- In  **Library**, hover over an image then click .

The selected image is downloaded to the computer.

11.1.6 Delete an image file from the unit

- In  **Library**, hover over an image then click .

The selected image is deleted from the Library.

11.1.7 Manage Library from the Front panel

It is also possible to manage Library images from the front panel in the **Export** menu:

- Download images from a USB drive to the Library (one at a time).
- Download images from the Library to a USB drive (one at a time).
- Delete one or all images from the Library.
- It is also possible to Export and Import the entire Library by exporting the Device configuration and filtering only Images.

11.2 Images

11.2.1 Images main screen

In  **Images**, all images presets are displayed in a Grid view.

The following information are displayed per image slot:

- Resolution
- Image slot capacity
- Image slot number
- Image slot label
- The tallies turn red and green if the image slot is used in a **Program** and/or **Preview** Screen ●●.



Note: - LivePremier units can use up to 48 image slots.

- Up to 48 images can be displayed simultaneously in layers.

- Image slots have a capacity set in  **Preconfig** >  Images. For more information, see 7.6 *Preconfig* > *Images* page 64.

11.2.2 Image slots settings

In  **Images**, click an image slot to open its settings. The selected image slot is highlighted in the interactive slot grid and all image slot information is listed next to the image slot preview.

- Click **Images** to return to the image slot Grid.
- In the header, rename the selected image slot.
- On the interactive slot grid, hover over an image slot to display the image slot preview.
- On the interactive slot grid, click an image slot to open its settings.

11.2.3 Downscale to capacity

When an image resolution is higher than the image slot capacity, the unit can either resize the image to fit the capacity or display nothing.

This option named *Downscale to capacity* is available for each image slot.

11.2.4 Assign an imported image to an image slot

Tip: Click an image slot in the slot grid or use the arrows to browse through the image slots.

1. In  **Images**, click an image slot.
The image slot settings are displayed.
2. In Identification > Label, enter a label to rename the Image slot.
3. In Option, enable Downscale to capacity to resize the image when the image slot capacity is too low for the image resolution.
4. In Display, select an image from the Library to be used in this image slot.

The selected image is now loaded as an image slot and is ready to be displayed in layers.

11.2.5 Assign a timer to an image slot

Note: Timers can be displayed in Multiviewers without being assigned as image slots.

Timers can be assigned to image slots. They can then be used in layers just like regular images.

1. In  **Images**, click an image slot.
The image slot settings are displayed.
2. In Identification > Label, enter a label to rename the Image slot.
3. In Option, enable Downscale to capacity to resize the image when the image slot capacity is too low for the image resolution.
4. In Display, select a timer to be used in this image slot.

The selected timer is now loaded as an image slot and is ready to be displayed in layers.

11.2.6 Image signal

In  **Images**, select an image slot. In **Signal** (only if HDR Processing is enabled in Preconfig > System), the following settings are displayed:

Setting name	Description / Setting selection
HDR Processing	
Image Profile	Select the Dynamic range used for this output (Auto, SDR)
Luminance	Select the nit level used for this image slot.
BBC Mapping	(only for SDR with HLG BCC as internal profile) Inverse Tone Mapping or Direct Mapping - Use Inverse Tone Mapping if internal processing and main output are using Limited Range color space.
BBC Reference	(only for SDR with HLG BCC as internal profile) Scene Referred or Display Referred - Use Scene Referred for camera content. - Use Display Referred for computer content.
BBC OETF	(only for Scene Referred) Square Root or Strict

11.2.7 Image aspect

In  **Images**, select an image slot. In **Aspect**, set the Aspect ratio or set image crop.

Note: - Aspect ratio and Crop replaces the image slot content and affects every layer using it. If needed, use crop at layer level in Live.
- Aspect ratio and Crop set for an image slot remain when changing the image source.

11.2.7.1 Set image aspect ratio

Change the image aspect ratio in all layers. Use these settings to correct the image aspect ratio if needed.

Note: Change aspect ratio at layer level to keep the image unchanged.

Setting name	Description / Setting selection
Aspect Ratio	
Transform to	Set the final aspect ratio for the input. This will be the native aspect ratio in the layer. (Native; 5:4; 4:3; 16:10; 15:9; 16:9; 21:9 or Custom ratio)
Layer fill option	1:1; Centered; Fullscreen or Cropped

11.2.7.2 Set image crop

Crop image (ex: black bars) and keep only wanted area in layers.

Setting name	Description / Setting selection
Crop	
Finder	On/Off toggle. Display cropping area in output, use during setup and disable Finder to show the crop result output.
Top, Bottom, Left, Right	Enter cropping values (in pixels)

12 Formats and EDID

12.1 Formats

In  **Formats**, create and manage up to 16 custom formats. Custom formats are very useful for LED wall applications and non-standard display applications (ex: pixel frequency over 165MHz or Dual-link outputs with single link formats 2400x700@60Hz).

Custom formats can also be used to create custom EDIDs and then reset or request the preferred EDID of connected outputs and inputs.

Custom format creation is separated in two modes:

- In **CVT mode**, set the width, height and rate of the format and indicate if the format has reduced blanking intervals. The system computes the remaining format parameters according to the CVT 1.1 standard.
- In **FULL mode**, set all the parameters of the format (H&V front porch, H&V sync, H&V back porch, width, height, sync polarity, ...).

Tip: - Max horizontal timings: 8192 pixels

- Max vertical timings: 4096 lines

- Max frequency/rate: 144Hz

12.1.1 Create a custom format

1. Go to  **Formats**.
2. Select a Template format to prefill the settings.
3. Enter a label for the new custom format
4. Select CVT or Full mode.
5. Enter the format settings (use the help in the right panel).
6. Click **Check** to verify if the custom format is valid and can be processed by the unit.
The format validity and format capacity are returned.
7. If format is valid, click **Save as** then select a memory slot.
8. Click **Save**.

The custom format is added to the formats library and can be used as a format preset.

12.1.2 Edit a custom format

1. Go to  **Formats**.
2. Select the Custom format memory slot to edit as Template.
3. Edit the format settings.
4. Click **Check** to verify if the custom format is valid and can be processed by the unit.
5. If format is valid, click **Save as** then select the same memory slot.
6. Click **Overwrite**.

12.1.3 Delete a custom format

- In  **Formats**, hover over Custom format then click .

The selected Custom format is deleted from the formats library.

12.2 EDID

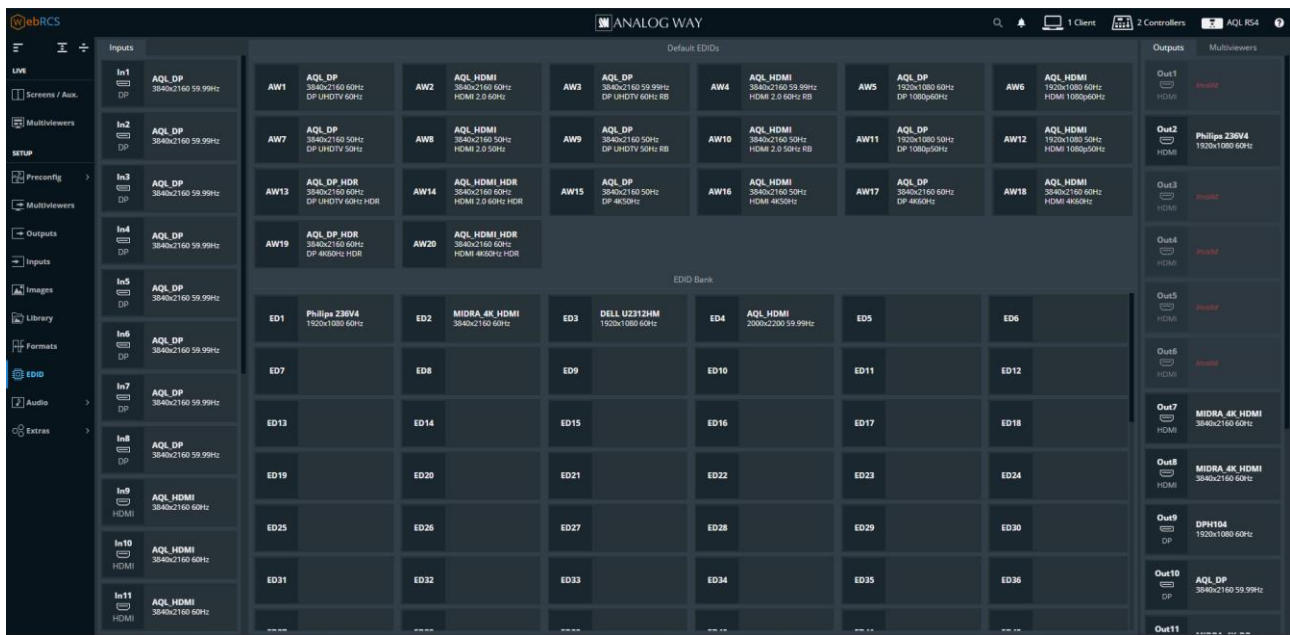

Fig. 21 - EDID menu

EDID is a metadata format used by displays to indicate their preferred format. A LivePremier unit receives EDIDs from connected inputs and outputs. It is possible to store these EDIDs in a memory called EDID bank. It is then possible to overwrite the preferred format of inputs and outputs.

Note: Extended EDID and DisplayID are also supported by LivePremier devices.

12.2.1 EDID bank

LivePremier units have 20 preinstalled EDIDs by default which correspond to standard formats for DisplayPort and HDMI outputs. In addition, the EDID bank can store up to 100 EDID memories saved from connected input/outputs, custom formats or EDIDs files imported from computer.

12.2.2 Save an EDID from inputs and outputs



To save EDIDs in the EDID bank, drag and drop EDIDs from inputs and outputs to the EDID bank.

12.2.3 Replace an Input EDID with an EDID from the bank

To set a new preferred format on an Input, drag and drop an EDID from the bank to the input slot.

To reset an input preferred format, hover over the input and click the reset icon .



12.2.4 Set a template format for an EDID

1. In  **EDID**, hover over an input EDID or an EDID created in the bank and click  in the top right corner to show more settings.
2. Click **Template** and select the format to use as EDID.
3. Click **Apply to EDID**.

The EDID is now usable as an input preferred format.

12.2.5 Set a custom format for an EDID



It is possible to change the preferred format of an input EDID with the settings of a created Custom format.

1. In  **EDID**, hover over an input EDID or an EDID created in the bank and click  in the top right corner to show more settings.
2. Click **Custom format** and select the memory to use as EDID.
3. Click **Apply to EDID**.

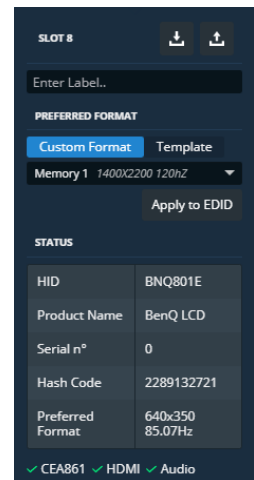

The EDID with custom format is now usable as an input preferred format.



12.2.6 Export an EDID to computer

1. In  **EDID**, hover over an EDID and click  in the top right corner to show more settings.
2. Click  to download the EDID to the computer.

12.2.7 Import an EDID from computer

1. In  **EDID**, hover over an EDID and click  in the top right corner to show more settings.
2. Click  and select the EDID file to upload from the computer to the unit.

12.2.8 Delete a custom EDID

- In  **EDID**, hover over an EDID in the EDID bank then click .

The selected custom EDID is deleted from the EDID bank.

13 Audio and Extras

13.1 Audio

LivePremier units are able to manage audio routing with and without Dante audio network. Using the Dante audio, LivePremier can manage up to 64 input channels and 64 output channels at 48 kHz.

In  **Audio** > Dante, check the status of the card, the channels and the networks.

In  **Audio** > Routing, assign audio channels from inputs and Dante receivers to outputs, multiviewers and Dante transmitters.

Note: - LivePremier is able to manage Dante routing. For Dante control, use Dante software.

- Dante audio can only be controlled from the Dante ports.

- Dante primary & secondary connections have a dedicated LAN separated from LivePremier control.

13.1.1 Reboot or reset the Dante audio card

In  **Audio** > Dante, the Dante card status is displayed (Dante version, network status, etc.)

- Click Reboot to restart the Dante card.

- Click Factory Reset to reset the firmware of the Dante card.

Tip: The update of the Dante card is integrated in the firmware update of the LivePremier unit. A pre-requisite is to install AW Dante Firmware v3.7.0.X (available on Analog Way's website) using the Dante Firmware Update Manager tool before updating the LivePremier firmware.

13.1.2 Audio routing

In  **Audio** > Routing, assign audio channels from receivers to transmitters.

LivePremier units can mix all audio channels. It is possible to route inputs to outputs (and multiviewers), inputs to Dante, Dante to outputs (and multiviewers) and Dante to Dante.

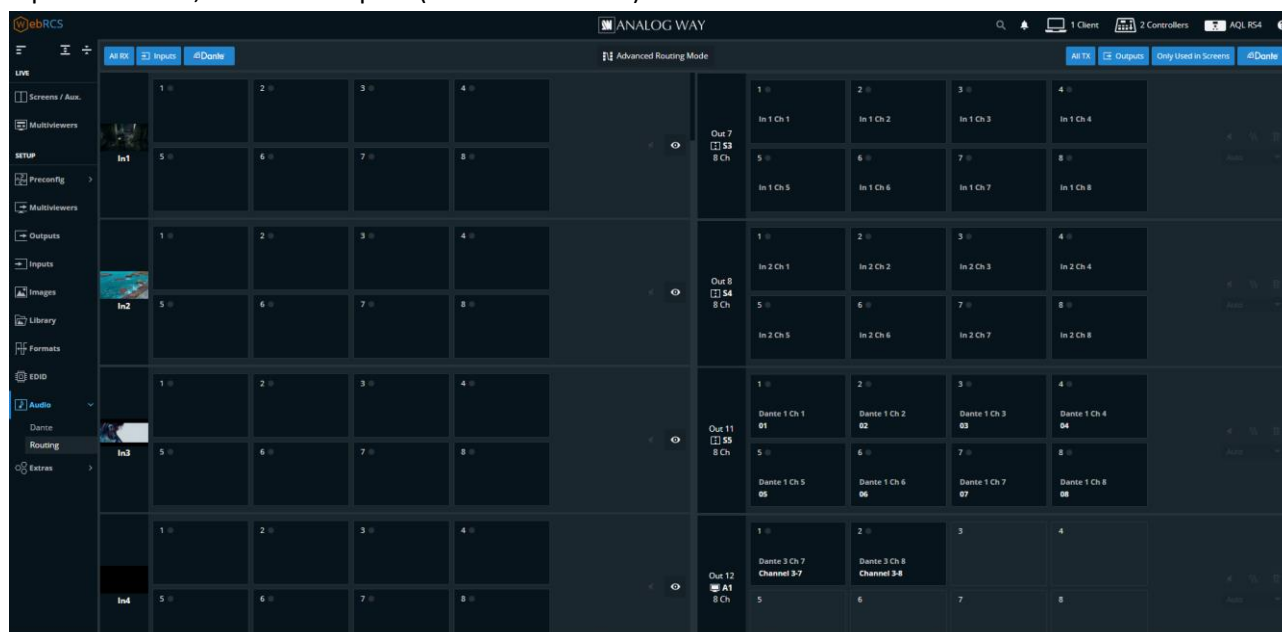







Fig. 22 - Audio routing menu

Audio routing menu:

Channel receivers (Inputs and Dante IN audio channels) are located in the left panel:

- Click  to mute the selected audio channels.
- Click  to highlight transmitter channels using this receiver channels.

Channel transmitters (Outputs and Dante OUT) audio channels are located in the right panel:

- Click  to mute the selected audio channels.
- Click  to send audio test tone.
- Click  to delete the audio routing.
- Set the number of channels to send (outputs only)
- Enter (or reset) channel labels (Dante only)

In the top bar:

- Use the filter buttons to show/hide audio channels.
- Enable **Advanced Routing Mode** for single channel routing.

13.1.3 Default audio routing

Default audio routing assigns all audio channels of a receiver to the audio channels of a transmitter.

1. In  **Audio** > Routing, drag and drop a receiver channel to a transmitter channel.

All audio channels of the receiver are routed to all audio channels of the transmitter.



Fig. 23 - Default audio routing

13.1.4 Advanced audio routing (single channel)

Advanced audio routing assigns one single audio channel of a receiver to one audio channel of a transmitter.

1. In  **Audio** > Routing, in the top bar, enable **Advanced Routing Mode**.
2. Drag and drop a receiver channel to a transmitter channel.

The selected audio channel of the receiver is routed to the selected audio channels of the transmitter.



Fig. 24 - Advanced audio routing (single channel)

13.2 Timers

Timers are time-based contents to be displayed in Screens, Aux Screens and Multiviewers. LivePremier units can generate up to four timers and three different modes.

There are three types of timers:

- Current time
- Count down
- Count up (Stopwatch)



13.2.1 Create a timer

1. In  **Extras** > Timers, select a timer slot to use.
2. If needed, enter a label.
3. Select the timer type:
 - a. In **Current time** mode, select the display format and set timer offset if needed.
 - b. In **Count down** mode, select the display format and set the countdown duration.
 - c. In **Count up** mode, select the display format.
4. For Count down and Count up modes, use the buttons to run, pause and stop the counters.
5. In **Color**, enter the hexadecimal color code or click the color preview to open the color setter to set a color and opacity for the content and the background.

Note: Current time displays the device time set in Dashboard > Device.

13.2.2 Control counter timers in Live menus

It is possible to run, pause and stop the counters directly in the source panel in *Live > Screens* and *Live > Multiviewers*.

1. In  **Screens** or  **Multiviewers**, open the timers source panel.
2. Hover over a timer and click  to show control options.
3. Click Setup to enter timer settings
Or use the buttons to run, pause and stop the counter.

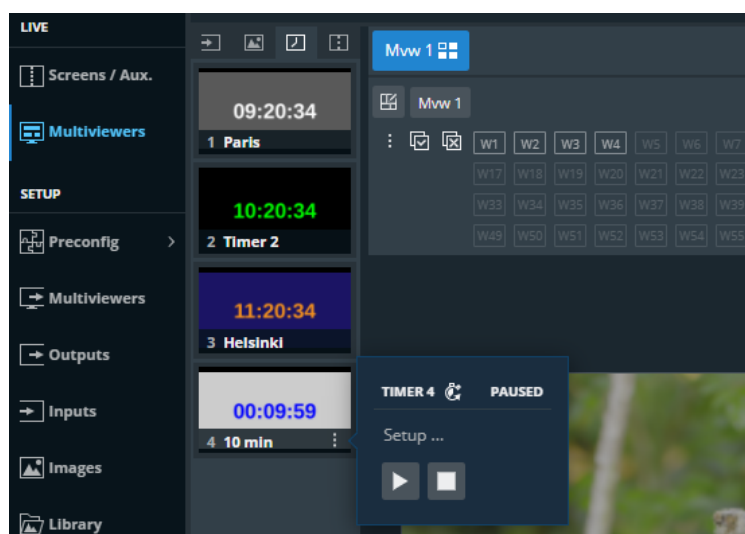



Fig. 25 - Timer controls in Multiviewer

13.2.3 Use timers in Screens and Aux. Screens

Note: Timers can be displayed in Multiviewers without being assigned as image slots.

Timers can be assigned to image slots. They can then be used in layers just like regular images.

1. In  **Images**, click an image slot.
The image slot settings are displayed.
2. In Identification > Label, enter a label to rename the Image slot.
3. In Option, enable Downscale to capacity to resize the image when the image slot capacity is too low for the image resolution.
4. In Content, select a timer to be used in this image slot.

The selected timer is now loaded as an image slot and is ready to be displayed in layers.

13.3 GPIO

The GPIO (or Tally) is a set of inputs/outputs to control the device externally and have a feedback from the device. LivePremier units are equipped with 2x GPI and 8x GPO.

13.3.1 Pins table and GPIO connection

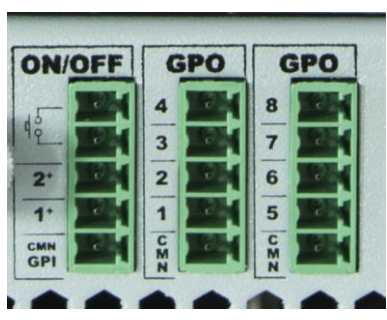

ON/OFF 2	GPO 4	GPO 8
ON/OFF 1	GPO 3	GPO 7
GPI 2	GPO 2	GPO 6
GPI 1	GPO 1	GPO 5
GPI return (common)	GPO return (common)	GPO return (common)

Fig. 26 - GPIO pins table

GPIO are optically isolated MOSFET, working as mechanical relays.

- GPI 1 and 2 have a common pin.
- GPO 1, 2, 3 and 4 have a common pin.
- GPO 5, 6, 7 and 8 have a common pin.

Each GPI can sink a current between 10mA/3V to 45mA/48V.

Each GPO can sink a current of up to 300mA maximum in the closed state and can accept up to 48V in the opened state.

The courant leakage is less than 1 μ A when opened and the resistance is less than 2 ohms when closed.

For more information, see *Fig. 27 - GPIO Phoenix connection example* page 88.

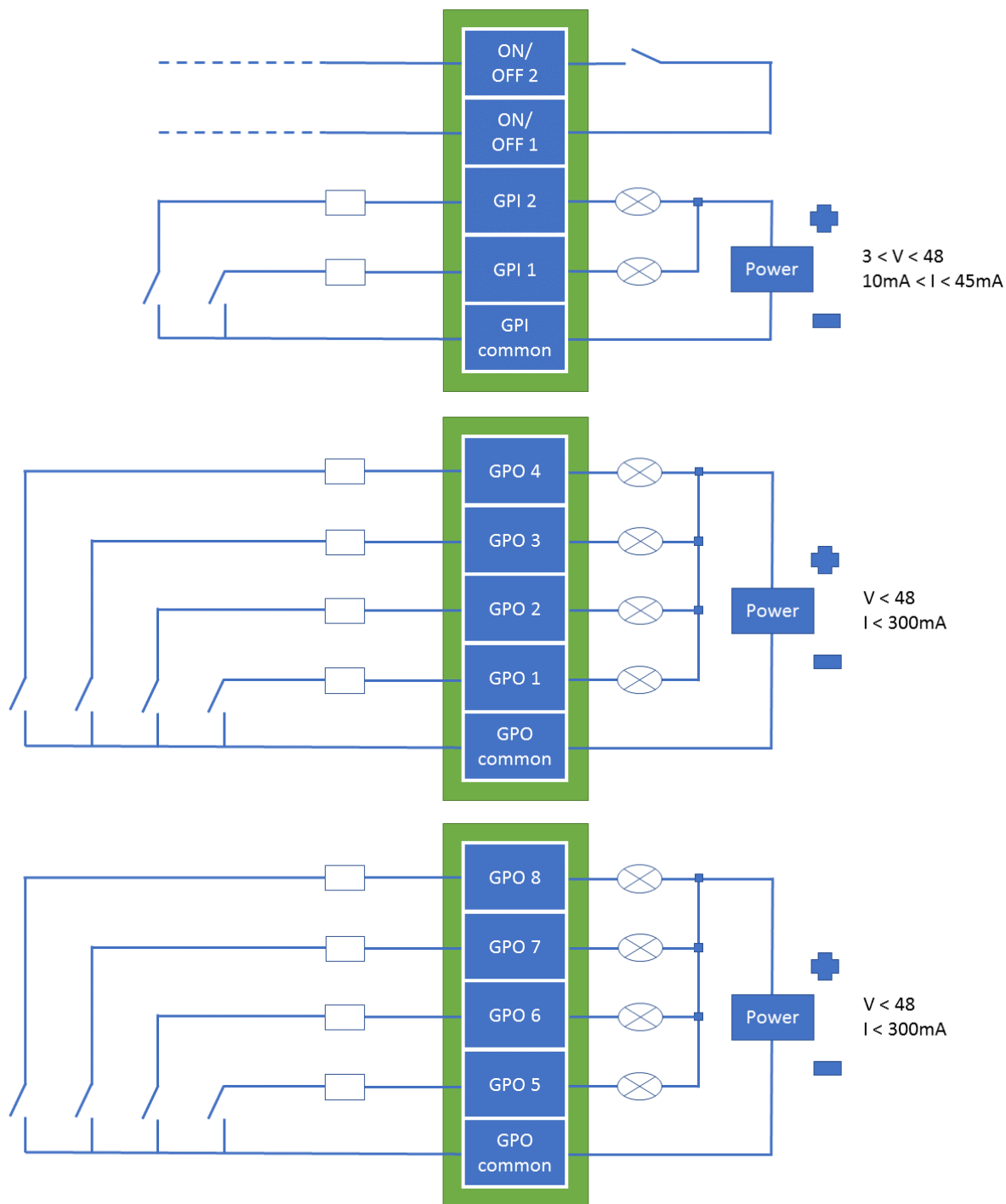



Fig. 27 - GPIO Phoenix connection example

13.3.2 On/Off switch pins

A switch can be placed between the On/Off pins to turn the LivePremier unit on and off. It will work as the front panel switch: when the device is on, closing the switch will request the device to power down. If the switch remains closed more than four seconds, a forced power down is performed. When the device is off, closing the switch will turn on the device.

13.3.3 Set GPIO in the Web RCS

In  **Extras** > GPIO, set the GPI and GPO actions.

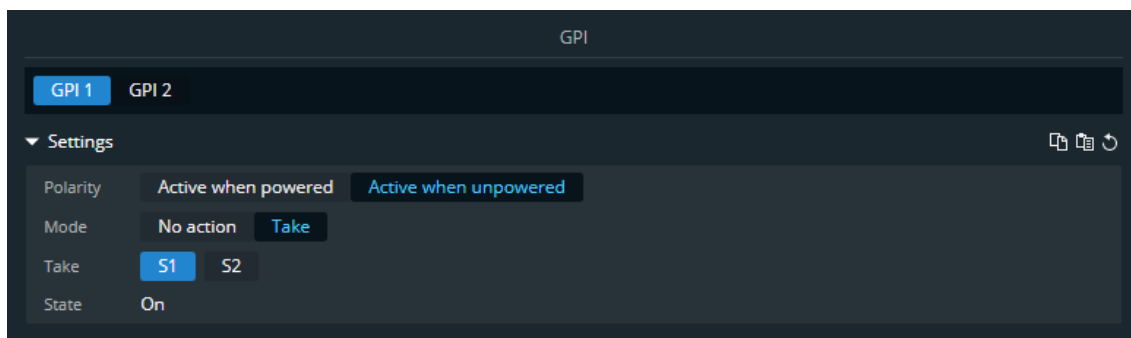

Fig. 28 - GPI

Setting name	Description / Setting selection
Polarity	Set when the GPI connector is active (when powered or when unpowered)
Mode	Select No action to disable triggers from this GPI. Select Take and associate a Screen to trigger the transition when using the GPI
Take	In Take mode, select the Screen to take when triggering the GPI
State	Check if the GPI is currently On or Off



Fig. 29 - GPO

Setting name	Description / Setting selection
Polarity	Set the GPO connector status when active (Closed or Opened)
Mode	In Manual mode, the state can be defined by a user action through the Web RCS or by an automation controller. In Tally mode, the tally level will change when a defined input is used in a Screen.
Screen X (one line per enabled Screen in Tally mode)	Set the association of Input-Screen for Tally mode. Select one input per Screen to return in the tally.
State	In Manual mode, set if the GPO is currently On or Off In Tally mode, check if the GPO is currently On or Off

14 Screens / Aux.

 **Screens / Aux.** is the main page for controlling a show after all pre-configurations are set:

- Display content in layers in Screens and Aux Screens
- Create dynamic layer transitions
- Transition Preview to Program
- Save and Load Screen memories and Master memories

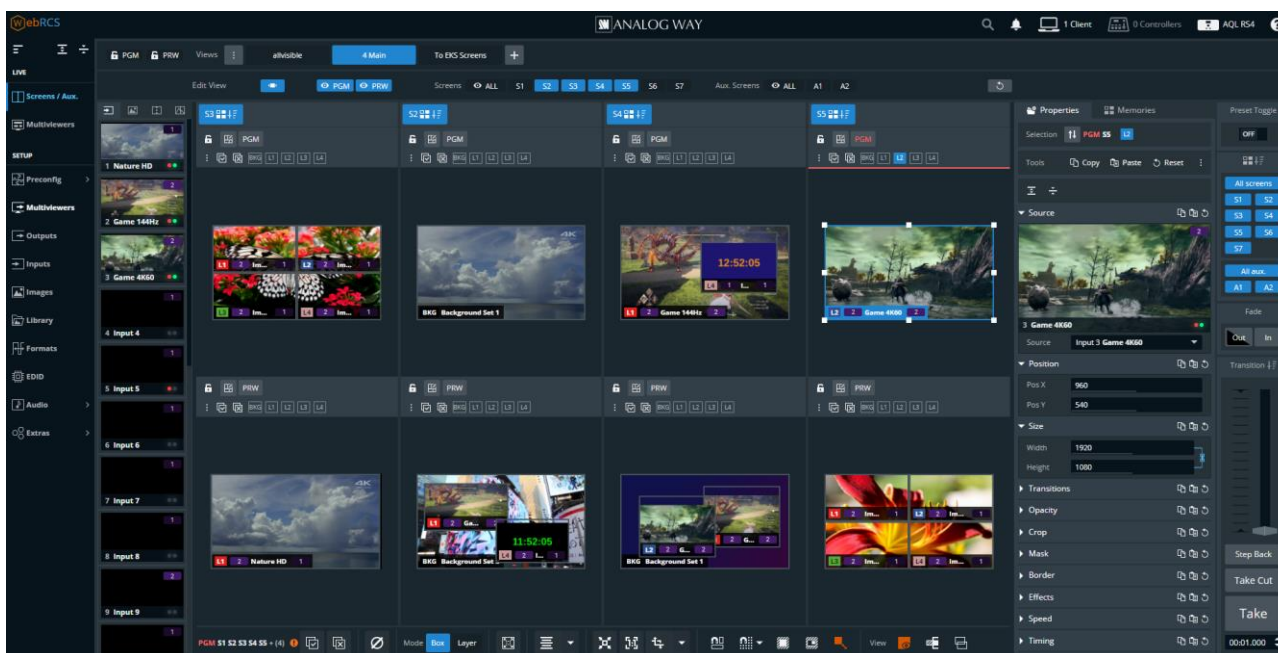



Fig. 30 - Live – Screens / Aux. menu

14.1 Screens menu interface

14.1.1 Program and Preview

 **Screens / Aux.** is composed of **Program (PGM)** and **Preview (PRW)** windows for each screen, as well as access to sources, layer properties, memories and transition panel. Program windows are always displayed on top of Preview windows.



14.1.2 Views

The **Live** menu offers a customizable view of the workspace for Screens and Aux Screens.

14.1.2.1 View filters – Top bar buttons



Fig. 31 - View filters

Setting name	Description / Setting selection
 PGM / PRW	Toggle to lock all the Screens and Aux Screens. Prevent edits during Live, or lock Program to only edit in Preview. Layers cannot be modified; Memories cannot be loaded but transition can be triggered.
 PGM / PRW / ALL	Toggle to show/hide all Program, Preview, Screens and/or Aux. Screens. Use the scroller when displaying more than five Screens.
	Reset to default view (Screens visibility, size and order).

Note: Hiding and locking Screens do not affect the Transition. To exclude a Screen from transition, see *14.1.8 Transitions - Right panel* page 95.

14.1.2.2 Resize and reorder Screen windows



In addition to showing and hiding Screens, it is also possible to resize and reorder the Screens in the interface.

- Use drag and drop on a border to resize the Screen width or height.
- Use drag and drop on a Screen name to move it and change the Screens order.

14.1.2.3 Save a view memory

The user can save custom views in memories.

Note: Screen locks are excluded from view memories.

1. In  **Screens / Aux.**, edit the workspace.
2. In Edit View, select the Screens and Aux. Screens to show/hide.
3. Resize and reorder the Screens.
4. In Views, click  to create a view memory with the current view.
5. Enter a name for the View memory.

14.1.2.4 Load / edit a view memory

1. In  **Screens / Aux.**, click a view memory.





The selected view memory is loaded to the workspace.

If changes are made to the view, a * appears in the view memory.

2. Click the view memory to show more options.
3. Click **Save** to overwrite the view memory with the new settings.

Or click **Revert** to reload the view memory.

14.1.2.5 Rename, hide or delete a view memory

- In  **Screens / Aux.**, click  in Views to open a detailed view of all view memories.
 - Click the label to rename a view memory.
 - Click  to hide a view from the bar.
 - Click  to delete a view memory.

14.1.3 Sources - Left panel

The Sources are located in the left panel. Click the icons to show the corresponding sources:

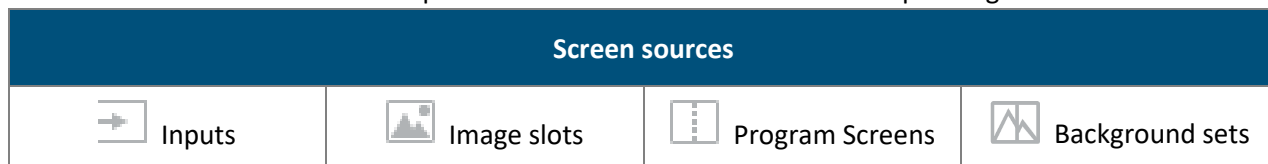



Note: - Program Screens can only be used as content for Aux Screens and Split layers.

- Background sets can only be used in Background layers.

The following information are displayed per source content:

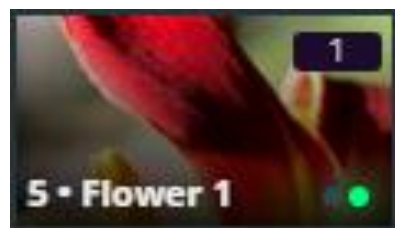
- Resolution (for inputs)
- Source capacity
- Source number
- Source label
- The tallies turn red and green if the content is used in a **Program** and/or **Preview** Screen ●●.









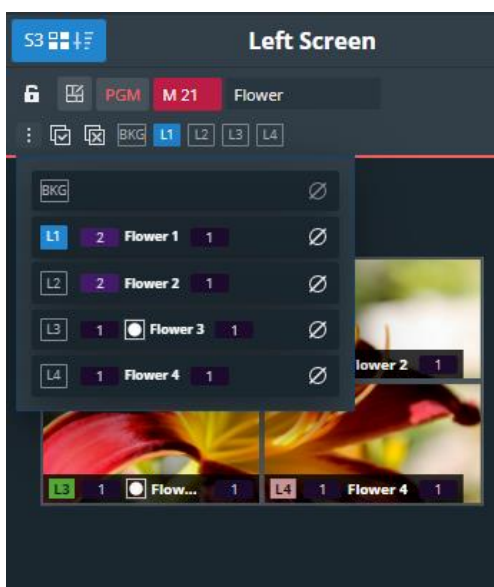

- Click  on the bottom-right corner of a source thumbnail to open options (ex: Freeze an input or access the setup menu for the selected source).

14.1.4 Layer selection

This bar shows tools and all available layers for the corresponding Screen.



Setting name	Description / Setting selection
	Toggle to include / exclude the Screen or Aux from transition selection
 or 	Toggle to lock the selected PGM or PRW Screen. Layers cannot be modified; Memories cannot be loaded but transition can be triggered.
	Open the layout editor, see 14.1.5 Screen layout editor page 93 .
PGM or PRW	Open the Screen options, see 14.1.6 PGM and PRW buttons page 93 .
	Open a detailed view of all layers in the selected Screen (layer capacity, source number and source capacity). Click  to empty the layer content and keep other properties
	Select all layers in this Screen
	Deselect all layers in this Screen
Layer letter	Select a layer (hold Ctrl or Shift to select multiple layers)

14.1.5 Screen layout editor

Click  to open the layout editor, a smart tool to place layers in the Screen easily.

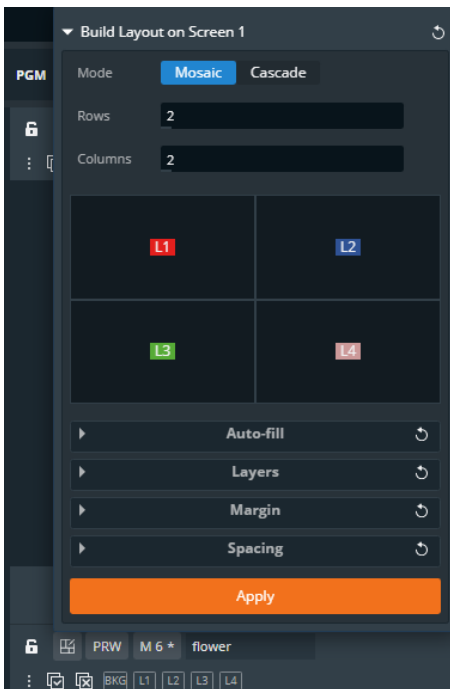

Setting name	Description / Setting selection
Mode	Mosaic places layers in custom grid. Mosaic layout automatically arranges the layers in rows. The last slot is empty if the number of layers is odd. Cascade places all layers in cascade except Layer 1 in Fullscreen.
Columns & Rows	Create a custom grid for the Mosaic mode
Autofill	Select the source content to put in layers
Layers	Select layers to include/exclude from this layout
Margin	Reduce the area of this layout (ex: Top: 50% will ignore the top half of the Screen)
Spacing	In Mosaic mode, set gaps between columns and/or rows

14.1.6 PGM and PRW buttons – Screen controls



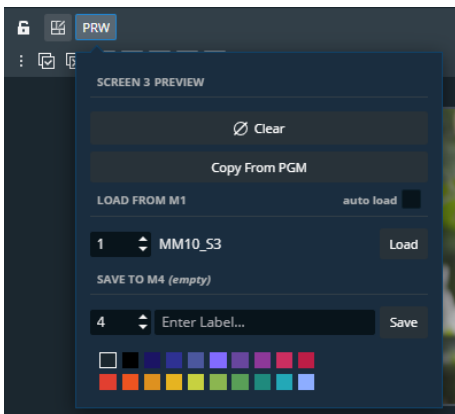







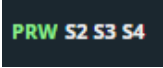





Click the **PGM** or **PRW** button in any Screen to open options.



Setting name	Description / Setting selection
 Clear	Empty the layers content and keep other properties for this PGM or PRW Screen
Copy from PGM	Copy layers settings from the corresponding PGM Screen (PRW only)
Load from	Load the Layer settings from a selected Screen Memory Enable auto load to display on Screen directly when selecting the Screen memory
Save to	Save the current Layer settings for this PGM or PRW Screen in a selected Screen memory
Label	Enter a label for the Master Memory. Select a color for the memory slot.

14.1.7 Bottom bar buttons

In addition to the layout editor, use the buttons in the bottom bar to help setting the layers in Screens.

Button	Button description
Action buttons	
	Screen selection for transition (same as the Screen transition filter in the right panel)
	Select all layers in the Screens selected for transition (indicated on the left side)
	Deselect all layers
	Empty the layers content and keep other properties for the selected layers
Mode	Box mode: the layer selection is considered as a box (ex: Middle center position puts the center of the box in the center of the Screen). Layer mode: all selected layers will be affected (ex: Middle center position puts the selected layers overlapped in the center of the Screen)
	Scale the layer selection to full screen
	Align the layer selection (Top, Bottom, Left, Right, Corner, Center, Horizontal or Vertical)
	Set layer size to source ratio (reduce size to cancel empty area of the layer)
	Set layer size to content size (5:4, 4:3, 16:10, 15:9, 16:9, 21:9 or source size)
	Set layer size to an aspect ratio
Assist buttons (On/Off toggle buttons)	
	Snap to Screen border and other layer borders
	Snap to grid cells Click the arrow to set the grid (columns & rows)
	Force layers outside of Screen to snap to Screen borders
	Force layers to stay inside of Screen borders
	Keep aspect ratio
Interface buttons (On/Off toggle buttons)	
	Hide empty and preempted items (layers and sources)
	Hide content outside of Screen borders
	Hide content to display only layers wireframe

14.1.8 Transitions - Right panel

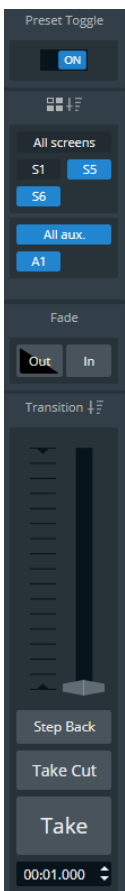

Setting name	Description / Setting selection
Preset Toggle	Copy Program to Preview after the transition. If Preset Toggle is enabled for a Screen, the layers in PGM replace the layers in PRW during a Take or Take Cut (“swap” effect). If Preset Toggle is disabled, the layers in PRW are copied to PGM and remain in PRW Screens during a Take or Take Cut .
Screen transition filter	Select the Screens and Aux affected by transition (by default, all Screens and all Aux are selected). Also indicated in the bottom bar.
Fade Out	Fade the selected screens to black
Fade In	Fade the selected screens to return from black
T-Bar	Transition the selection manually
Step Back	Revert the last change in layer settings. Does not work with a deletion.
Take Cut	Instant transition. Replace PGM layers with the PRW layers for the selected Screens with an immediate cut effect. The Global transition duration and the layers settings for Transitions, Speed and Timing are Not applied.
Take	Replace the PGM layers with the PRW layers for the selected Screens. Set the Global transition duration under the Take button (minutes:seconds.milliseconds). The layers settings for Transitions, Speed and Timing are applied to the Take .

14.2 Layer properties

When a layer is selected, the following layer settings are displayed in the Properties tab:

Setting name	Description / Setting selection
Source	Select a content for this layer.
Position	Set layer Vertical and Horizontal position in pixels.
Size	Set layer Height and Width in pixels.
Transitions	Set Opening and Closing transition during Take.
Cut & Fill	Set Cut & Fill. Displayed if enable at layer level in Preconfig. For more information, see <i>14.2.4 Cut & Fill effect</i> page 98.
Opacity	Set layer transparency.
Crop	Set layer cropping (zoom effect with content resized) in percentage or pixels (top, bottom, left and right) and layer aspect (None; 1:1; Centered; Fullscreen; Cropped).
Mask	Set layer masking (content not resized) in percentage or pixels (top, bottom, left and right).
Border	Set a layer border and layer shadow.
Effects	Set color filters (Black and white; Negative; Sepia; Solar) and Horizontal or Vertical flip.
Speed	Set the acceleration curve for the transition during Take.
Timing	Set the timings for delayed layer transition during Take.

14.2.1 Layer selection and tools

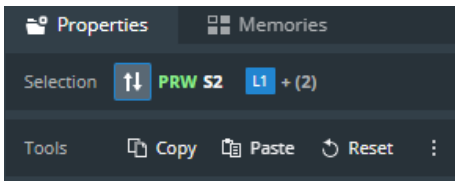

Setting name	Description / Setting selection
	Keep the layer selection and toggle to Program or Preview
	Current layer selection. The layer indicated is the Reference layer. The following layers will have the same settings applied if possible.
Copy / Paste / Reset	Copy, paste or reset multiple layer properties. By default, all layer properties are selected. Click to filter the selection.

14.2.2 Layer position and size

14.2.2.1 Set layer position with the layout editor

Layouts are predefined templates arranging layers automatically in one Screen.

1. In **Screens / Aux.**, click in the selected Screen to open the layout editor.
2. Create a custom layout in Mosaic or Cascade mode.
3. Auto-fill the layers with a type of source.
4. Select layers to include/exclude from the layout.
5. Apply the layout on Screen.

All the Screen layers are arranged automatically. For more information, see *14.1.5 Screen layout editor*, page 93.

14.2.2.2 Set layer position and size manually

1. In **Screens / Aux.**, select a layer.

The selected layer is highlighted.

2. Use drag and drop on the layer to move it in the Screen.
3. Use drag and drop on a layer border point to change its size.

It is also possible to use the Properties panel:

4. Go to Properties, click **Position** and **Size** to show the corresponding settings.
5. Set the Position and Size by entering values or using drag and drop.

Tip: - In the **Size** property, click to keep the aspect ratio when changing the size values.

- Use bottom bar buttons (Keep aspect ratio, snap to items) to have layers of equal size or alignment. When enabling snap to item, layer borders are automatically attracted to other objects (Screen border, layer border, grid snap point) to match their position or size.

14.2.3 Layer source

14.2.3.1 Assign content to a layer

1. In  **Screens / Aux.**, click a source icon in the left panel.
2. Select a Layer or make sure it is available for drag and drop.
3. Drag a content and drop it in the layer.

The content thumbnail is displayed in the layer with the source label and capacity at the bottom.



Tip: It is also possible to assign a content in other ways:

- Drag and drop the selected content into the layer letter icon on the top of each screen.
- Select a Layer then go to Properties > Source and select the content in the dropdown list.

14.2.3.2 Set a colored layer

1. In  **Screens / Aux.**, select a layer.
2. In **Properties**, click **Source** to show the corresponding settings.
3. In the Source dropdown list, select **Color**.
4. In Color, enter the hexadecimal color code or click the color preview to open the color picker.

14.2.3.3 Assign content to a Screen backgrounds

1. In  **Screens / Aux.**, click the Background sets icon  in the left panel.
2. Drag a Background set to a Screen background layer or BKG icon.

The Background set content is displayed in the Screen background.

Note: For more information on Background sets, see *7.7.1 Background sets* page 65.

14.2.3.4 Set a colored background

In addition to the eight background sets, each Screen is able to display a color in the background layer.

1. In  **Screens / Aux.**, select a background layer (BKG).
2. In **Properties**, click **Source** to show the corresponding settings.
3. In the Source dropdown list, select **None**.
4. In Color, enter the hexadecimal color code or click the color preview to open the color picker.



Note: - The background color is always present and can be displayed during a background set Crossfade.

- By default, all Screens display a background with black color (#000000).

14.2.3.5 Remove a content from a layer

1. In  **Screens / Aux.**, select one or multiple layers.
2. Press the **Del** key to remove all layer's content (this cannot be reversed).
The selected layers are empty but other properties are kept.

Tip: It is also possible to remove a content in other ways:

- Use the PGM or PRW buttons to clear the entire Screen
- Click  next to the layer letter icons then click  to clear the corresponding layer.
- Go to Properties > Source, then click  or select None in the source dropdown list.

14.2.4 Cut & Fill effect



Cut & Fill keys the content of a layer using an input or an image as the alpha channel. Usually, the Cut content (or mask), is a grey level content: the darker the grey level, the more transparent the Fill content.

Note: If a colored content is used as Cut, the Luma level of the content is used to key the Fill content.



14.2.4.1 Cut & Fill uses resource

The Cut & Fill feature must be enabled in the Preconfig as it uses the resources of two layers of same capacity.

If needed, go to  **Preconfig** >  Screens / Aux Screens > Screens tab to add the Cut & Fill feature to the corresponding layer. Only this layer will be able to use Cut & Fill.

Note: For more information on layer creation in Preconfig, see 7.3.7 *Create a Screen* page 54.

14.2.4.2 Set Cut & Fill in layer

1. In  **Screens / Aux.**, select a layer with Cut & Fill .
2. Assign a content in the layer.
3. In **Properties**, click **Cut&Fill** to show the corresponding settings.
4. Toggle the Enable button.
5. In **Source**, click the dropdown list and select the Cut content.

The Cut & Fill effect is set.

6. If needed, use the Curve setting to adjust the transparency level of the Cut & Fill.
7. If needed, enable the Negative filter to invert the cutting levels (bright content becomes transparent).
8. If needed, set flipping or cropping for the Cut content.

14.2.5 Set layer opacity

1. In  **Screens / Aux.**, select a layer.
2. In **Properties**, click **Opacity** to show the corresponding setting.
3. Set the transparency level with a value from 0 to 256.

14.2.6 Set layer crop and aspect

Layer crop is set for a layer and only affects the content used in this layer without changing the native content.

1. In  **Screens / Aux.**, select a layer.
2. In **Properties**, click **Crop** to show the corresponding settings.
3. Set the cropping per side in percentage or pixels.
4. In **Aspect**, set how the content is filling the layer (**1:1; Centered; Fullscreen, Cropped or None**).

Note: - The aspect set at layer level overrides the aspect set at content level (input or image).

- When multiple layers are selected, the crop is set on the following layers in percentage so the ratio stays the same even with content with different resolutions.

14.2.7 Set layer mask

Layer mask looks like an erasing effect and the content is not resized. It is set for a layer and only affects the content used in this layer without changing the native content.

1. In  **Screens / Aux.**, select a layer.
2. In **Properties**, click **Mask** to show the corresponding settings.
3. Set the masking per side in percentage or pixels.

Note: When multiple layers are selected, the crop is set on the following layers in percentage so the ratio stays the same even with content with different resolutions.

14.2.8 Set layer border

1. In  **Screens / Aux.**, select a layer.
2. In **Properties**, click **Border** to show the corresponding settings.
3. Toggle **Edge** to apply layer border settings.
4. Toggle **Smooth** to create a fading effect on the borders.
5. In **Edge / Smooth**, enter the hexadecimal color code or click the color preview to open the color picker.
6. Set the H size, V size and Opacity.
7. If needed, toggle **Round** to apply round corners settings and set the round corner radius.

14.2.9 Set layer smooth border

Setting a smooth border without enabling **Edge** creates a smooth effect around the content.

1. In  **Screens / Aux.**, select a layer.
2. In **Properties**, click **Border** to show the corresponding settings.
3. Keep the **Edge** toggle disabled.
4. Toggle **Smooth** to create a fading effect around the content.
5. In **Edge / Smooth**, set the H size, V size and Opacity.
6. If needed, toggle **Round** to apply round corners settings and set the round corner radius.

14.2.10 Set layer shadow

1. In  **Screens / Aux.**, select a layer.
2. In **Properties**, click **Border** to show the corresponding settings.
3. Toggle **Shadow** to apply layer shadow settings.
4. Set the X and Y positions for the shadow direction.
5. Set the shadow Opacity level.
6. If needed, toggle **Round** to apply round corners settings and set the round corner radius.

14.2.11 Set layer color filter

1. In  **Screens / Aux.**, select a layer.
2. In **Properties**, click **Effects** to show the corresponding settings.
3. In **Filter**, toggle the On/Off buttons to enable the corresponding effects (**Black and White**; **Negative**; **Sepia**; **Solar**).

14.2.12 Set layer Horizontal and Vertical flip

1. In  **Screens / Aux.**, select a layer.
2. In **Properties**, click **Effects** to show the corresponding settings.
3. In **Transform**, toggle the On/Off buttons to enable the corresponding effects (**H flip** and **V flip**).

14.3 Layer transition

The transition is the animations of the layers during **Take**. Each layer can be defined by an opening and a closing transition. The opening effect is triggered when the layer switches from one source to another or when the layer appears on Screen. The closing effect is triggered if the layer is not used in the new screen. The global transition Timing is set under the **Take** button.

Note: Transition effect, timing and speed are not applied when using the **Take Cut** button.

- When the output rate is set to 120Hz or higher, the transitions refresh every other frame.

14.3.1 Set layer transition effect

1. In  **Screens / Aux.**, select a layer.
2. In **Properties**, click **Transitions** to show the corresponding settings.
3. In **Opening**, select a transition type and transition direction.
4. In **Closing**, select a transition type and transition direction.
5. If needed, disable Cross effect and Cross depth.

Cross Effect	Seamless effect between two contents (ex: Crossfade). If disabled, the first content disappears before the next one appears.
Cross Depth	Same content changing Layer (ex: L1 to L4). The layer moves in depth to reach new z-position. If disabled, the transition is done inside the Layers. The content closes inside one layer and opens in the new layer.

Note: Cross effect and Cross depth are seamless features that only applies to mixing layers.

14.3.2 Set layer transition timing

1. In  **Screens / Aux.**, select a layer.
2. Set the global transition timing under the **Take** button.
3. In **Properties**, click **Timing** to show the corresponding settings.
The Opening and Closing graphs display the timings for all the layers in the selected Screen.
4. In **Opening**, enter a starting time and an ending time for the selected layer.
5. In **Closing**, enter a starting time and an ending time for the selected layer.
It is also possible to use drag and drop directly on the graphs.

14.3.3 Set layer transition speed

1. In  **Screens / Aux.**, select a layer.
2. In **Properties**, click **Speed** to show the corresponding settings.
3. Toggle **Linear** to use a linear speed and hide the other settings.
If Linear is Off, the Speed curve is displayed.
4. Set the starting and ending speed to create a custom speed.

14.4 Aux Screens

Outputs used in Aux Screens can display up to 8 layers with capacity **1**.

Aux layers are dynamic, assigning a content with a capacity higher than **1** will preempt the next Aux layer(s).
One capacity needed = one layer preempted.

For example: an Aux Screen is set with 6 layers. Assigning a 7860x2160 Program Screen (capacity **4**) to layer 1 will preempt layer 2, 3 and 4. Layer 5 and 6 remain available.

14.4.1 Aux layers limitations

Aux layers support most of the same features as Screen split layers (input, image/timer, and screen program as source; size, position, crop, timings, etc.).

Aux layers do not support:

- Seamless transitions, one content will disappear before the new one is visible.
- Alpha channels, transparent content is displayed in the same color as the background layer.
- Border settings.
- Cut & Fill effect.

The Aux background layer can only support one monochrome color as a source (no input, image or background set).



15 Memories

■ ■ **Memories** are used to save layers settings.

Master memory	Saves/loads multiple Screen memories at once (one per screen).
Screen memory	Saves/loads the layers settings for one Screen or Aux Screen.
Layer memory	Saves/loads the settings for one layer.

The LivePremier is able to save up to 500 Master memories, 1000 Screen memories and 50 Layer memories. Memories can be saved from and loaded to Program or Preview Screens.

15.1 Memories tab

In  **Screens / Aux.**, next to the Properties tab is the  **Memories** tab located in the right panel.

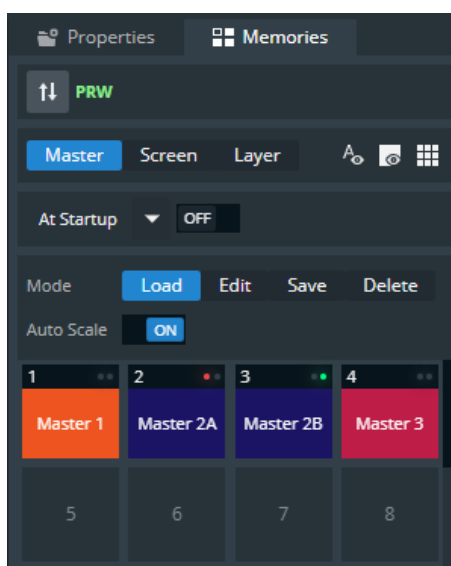





Fig. 32 - Memories tab

Button / Setting	Description / Setting selection
	Show / hide Memories labels
	Show / hide empty Memory slots
	Toggle the number of Memory slot per column (1; 2 or 4 per column)
At Startup	(Master Memories only) Enable and select a Master memory slot to be loaded in Preview and Program Screens when starting the LivePremier unit.
Auto Scale	Toggle to rescale the layers to fit the Screen(s) on load or keep the parameters as saved in the Memory.
	The tallies turn red and green if the content is used in a Program and/or Preview Screen ●●.



15.2 Master Memories

15.2.1 Save a Master memory from current Screens

Master memory is the default saving mode and can be used alone as it loads settings on all Screens. A Master memory saves the selected Screens in the current settings. Using Filters, select which Screens, Aux, Layers and Layer settings to save in the Master memory. By default, all Layers and all Layer settings are selected.

A Master memory is made of multiple Screen memories. Saving a Master memory actually saves one Screen memory per Screen. These Screen memories can be accessed when using the **Screen** mode.

Note: When a Master memory is loaded to Preview, only the Screens included in the memory are selected for Transition.

- In  **Screens / Aux.**, click the  **Memories** tab in the right panel.
- Select **Master** mode and click **Save** to open the Master memory saving window:

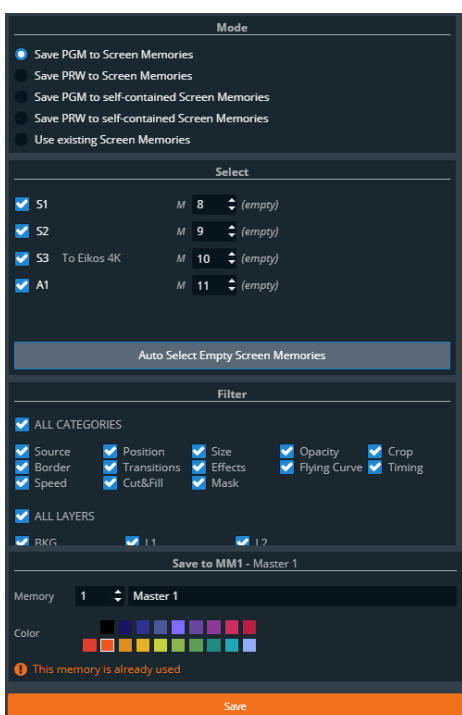

Setting name	Description / Setting selection
Mode	Select to save the current layers settings from Program or Preview Screens with or without creating Screen/Aux Memories (self-contained mode).
Select	Select the Screens and Aux to include/exclude from the Master Memory. Select the Screen Memory slots to use in the corresponding Screens. Click Auto select... to use the first empty slots.
Filter	Select the layer settings to include/exclude from the Master Memory. Select the layer to include/exclude from the Master Memory.
Save to	Select the Master Memory slot to use. Enter a label for the Master Memory. Select a color for the memory slot.



- Select the settings to save in the Master memory using the table above.
- Click **Save**.

Note:

- Selecting existing Screen memories and Master memories slot will overwrite them.
- Changing (and deleting) a Screen memory also affects a Master memory using it. If needed, create a duplicate of the Screen memory before making changes.

15.2.2 Save a Master memory from existing Screen memories

Because a Master memory is made from Screen memories. It is also possible to create a Master memory by using existing Screen memories.

1. In  **Screens / Aux.**, click the  **Memories** tab in the right panel.
2. Select **Master** mode and click **Save** to open the Master memory saving window:

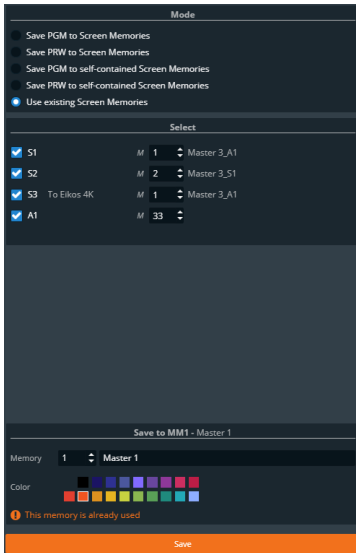



Setting name	Description / Setting selection
Mode	Select Use existing Screen Memories
Select	Select the Screens and Aux Screens to include/exclude from the Master Memory. Select the Screen Memory slots to use in the corresponding Screens.
Save to	Select the Master Memory slot to use. Enter a label for the Master Memory. Select a color for the memory slot.

3. Select the Screen memories to use in the Master memory.
4. Click **Save**.

Note: Changing (and deleting) a Screen memory also affects a Master memory using it.
If needed, create a duplicate of the Screen memory before making changes.

15.2.3 Load a Master memory

1. In  **Screens / Aux.**, click the  **Memories** tab in the right panel.
2. Select **Master** mode and click **Load**.
3. If needed, enable **Auto Scale** to adapt the loaded memories to fit the Screens.
4. Click a layer in Program or Preview.
5. Click a Master memory slot.



The Master memory is loaded to Program or Preview in the Screens selected in the Master memory.
The Screens selected in the Master memory are enabled for transition in the Screen selection filter.

Tip: It is also possible to drag a memory slot to a Program or Preview Screen.

15.2.4 Load a Master memory at startup

Load a user defined Master memory on Program and Preview when turning the LivePremier device on.

Note: Master Memory load at startup does not support Auto-scale. Use Screen Memories that match the Screen size in the Master Memory to load at startup.

1. In  **Screens / Aux.**, click the  **Memories** tab in the right panel.
2. Click **At Startup** and select a Master memory slot to load at startup.
3. Toggle **At Startup** to enable / disable the feature.

15.2.5 Edit a Master memory



1. Load a Master memory.
2. Click **Save** to open the Master memory saving window.
3. Select the settings to save.
4. Select the existing Master memory slot to edit.
5. Click **Save** to overwrite the previous Master memory.

15.3 Screen Memories

15.3.1 Save a Screen memory

A Screen memory saves the selected Screen in the current settings.

Using Filters, select which Layers and Layer settings to save in the Screen memory. By default, all Layers and all Layer settings are selected.

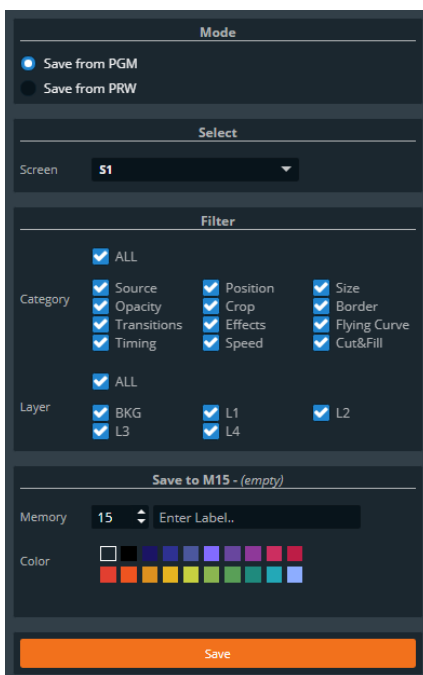

1. In  **Screens / Aux.**, click the  **Memories** tab in the right panel.
2. Select **Screen** mode.
3. Click **Save** to open the Screen memory saving window:



Setting name	Description / Setting selection
Mode	Select to save the current layers settings from Program or Preview Screen.
Select	Select the Screen to save
Filter	Select the layer settings to include/exclude from the Screen Memory. Select the layer to include/exclude from the Screen Memory.
Save to	Select the Screen Memory slot to use. Enter a label for the Screen Memory. Select a color for the memory slot.

4. Select the settings to save in the Screen memory using the table above.
5. Click **Save**.

15.3.2 Load a Screen memory

1. In  **Screens / Aux.**, click the  **Memories** tab in the right panel.
2. Select **Screen** mode and click **Load**.
3. If needed, enable **Auto Scale** to adapt the loaded memory to fit the Screen.
4. Use the  buttons or Screen transition filter to select the Screen(s).

The Screens selected for Screen Memory loading are also indicated under the  **Memories** tab:

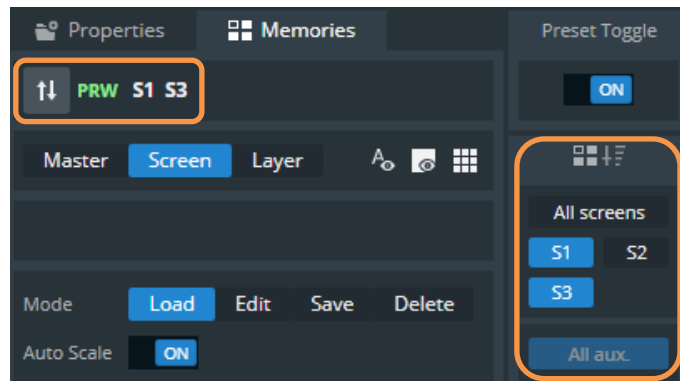

5. Click a Screen memory slot.

The Screen memory is loaded to all Screens selected for transition in Program or Preview.

Tip: To affect a Screen memory to only one Screen, it is also possible to drag a memory slot to a Program or Preview Screen.

15.3.3 Edit a Screen memory

1. Load a Screen memory.
2. Click **Save** to open the Screen memory saving window.
3. Select the settings to save.
4. Select the existing Screen memory slot to edit.
5. Click **Save** to overwrite the previous Screen memory.

15.3.4 Quick overwrite or revert

When a Screen memory is loaded in a Screen, a button with the memory slot number appears. If changes are made to the Screen, a * appears next to the memory slot number.

1. Click the memory button to show more options.
2. Click **Save** to overwrite the Screen memory with the new layer settings.
Or click **Revert** to reload the Screen memory.

15.4 Layer Memories



15.4.1 Save a Layer memory

A Layer memory saves the selected Layer in the current settings.

Using Filters, select which Layer settings to save in the Layer memory. By default, all Layer settings are selected.

Note: - If multiple layers are selected, the memory saves the layer settings of the Reference Layer. The Reference Layer is the first layer selected, it is indicated above the Properties and Memories tabs.

- Master memories and Screen memories cannot point to Layer memories.

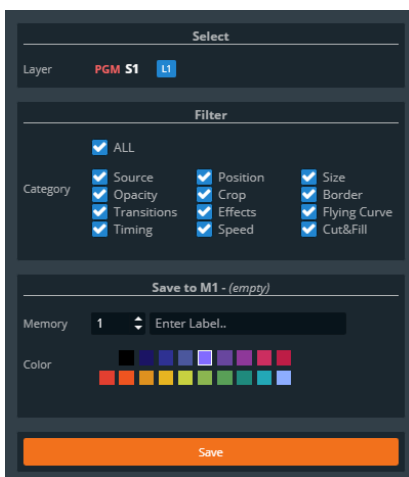

1. In  **Screens / Aux.**, click the  **Memories** tab in the right panel.
2. Select **Layer** mode.
3. Click **Save** to open the Screen memory saving window:



Setting name	Description / Setting selection
Select	Shows the selected layer
Filter	Select the layer settings to include/exclude from the Layer Memory.
Save to	Select the Layer Memory slot to use. Enter a label for the Layer Memory. Select a color for the memory slot.

4. Select the settings to save in the Layer memory using the table above.
5. Click **Save**.

15.4.2 Load a Layer memory

1. In  **Screens / Aux.**, click the  **Memories** tab in the right panel.
2. Select **Layer** mode and click **Load**.
3. If needed, enable **Auto Scale** to adapt the loaded memory to fit the Screen.
4. Click a layer in Program or Preview.
5. Click a Layer memory slot.



The Layer memory is loaded to the selected Layer in Program or Preview.

Tip: It is also possible to drag a memory slot to a Program or Preview Layer.



15.4.3 Edit a Layer memory

1. Load a Layer memory.
2. Click **Save** to open the Layer memory saving window.
3. Select the settings to save.
4. Select the existing Layer memory slot to edit.
5. Click **Save** to overwrite the previous Layer memory.

15.5 Rename a Memory



1. In  **Screens / Aux.**, click the  **Memories** tab in the right panel.
2. Select **Master**, **Screen** or **Layer** mode.
3. Click **Edit**.
4. Click  in the top right corner of the memory slot to open the **Label** and **Color** fields.
5. Enter a new name for the memory slot.

15.6 Change the color of a Memory slot

1. In  **Screens / Aux.**, click the  **Memories** tab in the right panel.
2. Click **Edit**.
3. Click  in the top right corner of the memory slot to open the **Label** and **Color** fields.
4. Select a color for the memory slot.

Tip: To reset all memory slots to default colors, click  on top of the memory slots and click **Reset colors**.



15.7 Reorder memories

1. In  **Screens / Aux.**, click the  **Memories** tab in the right panel.
2. Select **Master**, **Screen** or **Layer** mode.
3. Click **Edit**.
4. Drag a memory slot to a new place to organize the memory slots in a custom order.

Note: - Reordering memory slots does not change the memory slot number and does not impact external controllers and RC400T.
- Reordering Screen memories does not impact Master memories.

Tip: To reset to default order, click  on top of the memory slots and click **Reset order**.



15.8 Delete a memory

1. In  **Screens / Aux.**, click the  **Memories** tab in the right panel.
2. Select **Master**, **Screen** or **Layer** mode.
3. Click **Delete**.
4. Select one or multiple memory slots to delete.
5. Click **Delete** at the bottom of the slots.

16 Multiviewers

Tip: Go to  **Multiviewers** after all pre-configurations are set.

A Multiviewer is an output displaying a user customizable selection of Widgets as display resources. A Widget works like a layer and can display a program, preview, input, image or timer. One Multiviewer can display up to 64 Widgets.

In  **Multiviewers**, set the Multiviewers layout and Widgets. This menu displays one or two Multiviewers screens, depending on what is set in  Preconfig >  Multiviewers.

Note:

- Go to  Preconfig >  Multiviewers to enable One Multiviewer or Two Multiviewers.





-Go to Setup  Multiviewers to set the Label, Signal parameters, Patterns and Image correction.

16.1 Tips and recommendations

- Widgets cannot be placed on top of each other (overlap error).
- The same source cannot be used in more than one widget per Multiviewer.
- Two widgets using the same source in both Multiviewers are displayed at the same resolution (smallest widget).

16.2 Multiviewers menu interface

The menu  **Multiviewers** behaves much like the menu  **Screens**:

- Sources on the left panel:  Inputs;  Images;  Timers and  Screens.
- Widget letter icons and Bottom bar icons.
- Widget properties and Memories on the right panel.

Note: There are no transition or Program/Preview features in Multiviewers.

16.2.1 Sources - Left panel

The Sources are located in the left panel. Click the icons to show the corresponding sources:

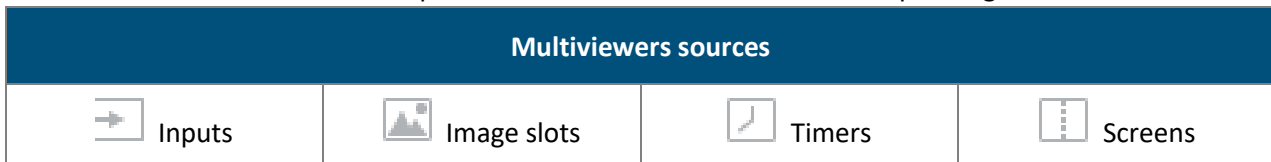



The following information are displayed per source content:

- Resolution (for inputs)
 - Source capacity
 - Source number
 - Source label
 - The tallies turn red and green if the content is used in a **Program** and/or **Preview** Screen ●●.
- Click  on the bottom-right corner of a source thumbnail to open options (ex: Freeze an input or access the setup menu for the selected source).



16.2.1.1 Control counter timers in Multiviewers

It is possible to run, pause and stop the counters directly in the source panel in Live > Multiviewers.

1. In  **Multiviewers**, click  Timers in the source panel.
2. Hover over a timer and click  to show control options.
3. Click Setup to enter timer settings
Or use the buttons to run, pause and stop the counter.

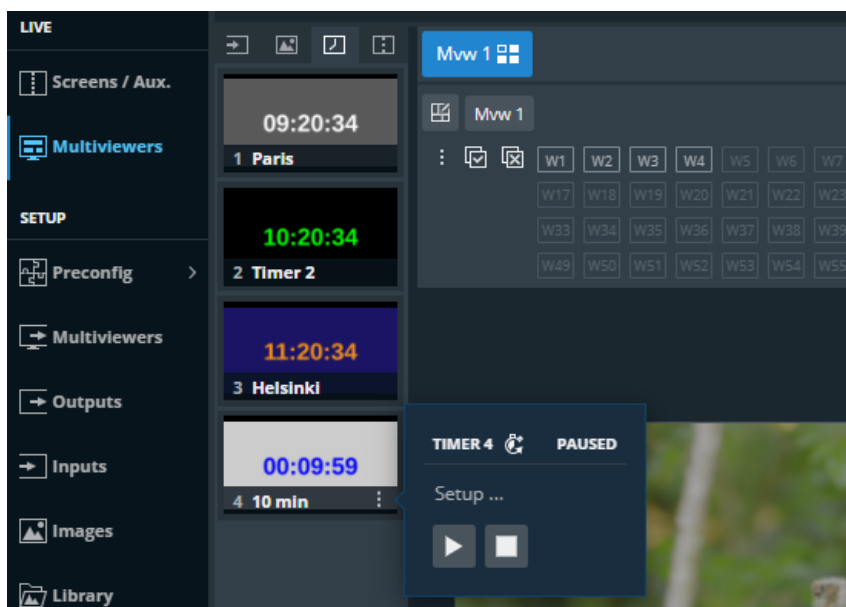



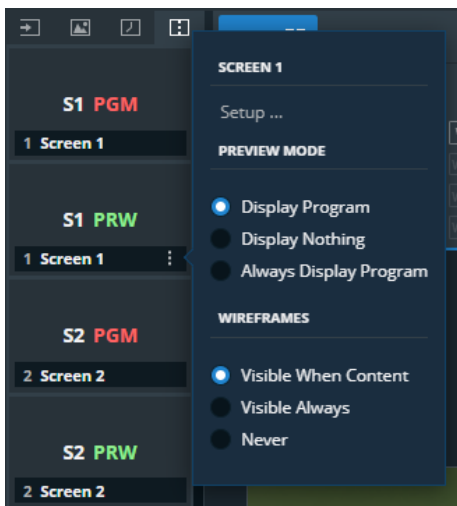

Fig. 33 - Timer controls in Multiviewer

16.2.1.2 Set Preview mode for Preview Screen widgets

1. In  **Multiviewers**, click  Screens in the source panel.
2. Hover a Preview Screen and click  to show preview options:







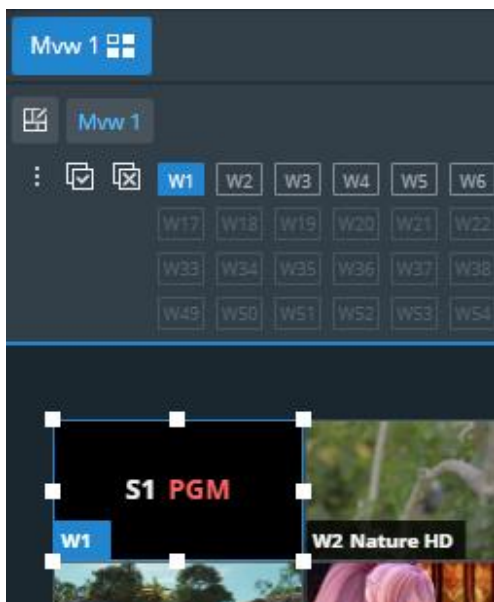

Setting name	Description / Setting selection
Preview Mode	Select what is displayed in the Preview widget: <ul style="list-style-type: none"> - Display Program during transitions - Display Nothing during transitions - Always Display Program content in the Preview widget
Wireframes	Select the visibility of the wireframes of the Preview Screen layers: <ul style="list-style-type: none"> - Layers wireframes displayed when content - Layers wireframes are always displayed - Layers wireframes are never displayed

Tip: It is possible to monitor both Program and Preview of a Screen in one Widget by using Always Display Program content and display Preview layers wireframe.

16.2.2 Widget selection

This bar shows tools and all available layers for the corresponding Screen.



Setting name	Description / Setting selection
	Select the Multiviewer for Memory load or <i>Select all widgets</i> button in bottom bar
	Open the layout editor, see 16.2.3 Multiviewer layout editor page 113.
	Open a detailed view of all widgets in the selected Multiviewer (source number). Click  to empty the widget content and keep other properties
	Select all widgets in this Multiviewer
	Deselect all widgets in this Multiviewer
Widget letter	Select a widget (hold Ctrl or Shift to select multiple widgets)





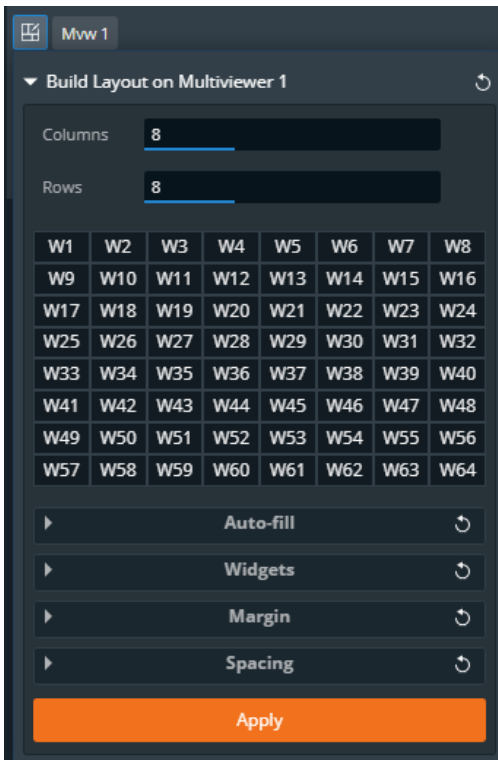



16.2.3 Multiviewer layout editor

Click  to open the layout editor, a smart tool to place widget in the Multiviewers easily.



Setting name	Description / Setting selection
Columns & Rows	Create a custom grid
Autofill	Select the source content to put in layers
Widgets	Select widgets to include/exclude from this layout
Margin	Reduce the area of this layout (ex: Top: 50% will ignore the top half of the Multiviewer)
Spacing	Set gaps between columns and/or rows

16.2.4 Bottom bar buttons

Button	Button description
Action buttons	
	Select all widgets in the selected Multiviewers (indicated on the left side)
	Deselect all widgets
	Empty the widgets content and keep other properties for the selected widgets
Assist buttons (On/Off toggle buttons)	
	Snap to Multiviewer border and other widgets borders.
	Snap to grid cells. Click the arrow to set the grid (columns and rows).
	Keep aspect ratio.
Interface buttons (On/Off toggle buttons)	
	Hide content to display only widgets wireframe.
	Hide empty and preempted items (layers and sources).

16.3 Widget properties



When a widget is selected, the following widget settings are displayed in the Properties tab.

Setting name	Description / Setting selection
View	Enable: Toggle to show/hide the widget. OSD (On Screen Display): - Off: Hide OSD information. - Basic: Only show the title of the source in widget OSD. - Detailed: Show full OSD information on the widget.
Source	Select a content for this widget.
Position/Size	Set widget Vertical and Horizontal position in pixels. Set widget Height and Width in pixels.

16.3.1 Widget position and size

16.3.1.1 Set widget position with the layout editor

Layouts are predefined templates arranging widgets automatically in one Multiviewer.

1. In  **Multiviewers**, click  in the selected Multiviewer to open the layout editor.
2. Create a custom layout in Mosaic or Cascade mode.
3. Auto-fill the widgets with a type of source.
4. Select widgets to include/exclude from the layout.
5. Apply the layout on Multiviewer.

All the Multiviewer widgets are arranged automatically. For more information, see *16.2.3 Multiviewer layout editor* page 113.

16.3.1.2 Set widget position and size manually

1. In  **Multiviewers**, select a widget.

The selected widget is highlighted.

2. Use drag and drop on the widget to move it in the Screen.
3. Use drag and drop on a widget border point to change its size.

It is also possible to use the Properties panel:

4. Go to Properties, click **Position** and **Size** to show the corresponding settings.
5. Set the Position and Size by entering values or using drag and drop.

Tip: - In the **Size** property, click  to keep the aspect ratio when changing the size values.

- Use bottom bar buttons (Keep aspect ratio, snap to items) to have widgets of equal size or alignment. When enabling snap to item, widgets borders are automatically attracted to other objects (Multiviewer border, widget border, grid snap point) to match their position or size.

16.3.1.3 2x2 Slicer mode with DPH104

When using a Multiviewer output in 2x2 Slicer mode with a DPH104, the signal is automatically divided in 2x2 following the selected format.

Tip: Use the layout editor to make sure the widgets are placed in their corresponding $\frac{1}{4}$ of the Screen.

16.3.2 Widget source - Assign content to a widget

1. In  **Multiviewers**, click a source icon in the left panel.
2. Select a widget or make sure it is available for drag and drop.
3. Drag a content to the widget.

The content thumbnail is displayed in the widget with the source label at the bottom.



Tip: It is also possible to assign a content in other ways:

- Drag and drop the selected content into the widget letter icon on the top of each Multiviewer.
- Select a widget then go to Properties > Source and select the content in the dropdown list.



16.4 Multiviewers memories

A Multiviewer memory saves the selected Multiviewer in the current settings. All widgets settings are saved/loaded. The LivePremier is able to save up to 50 Multiviewer memories.

16.4.1 Save a Multiviewer memory

1. In  **Multiviewers**, click the  **Memories** tab in the right panel.
2. Click **Save** to open the memory saving window.
3. Select the Multiviewer to save.
4. Select the memory slot and enter a label.
5. Select a color for the memory slot.
6. Click **Save**.

16.4.2 Load a Multiviewer memory



1. In  **Multiviewers**, click the  **Memories** tab in the right panel.
2. Click **Load**.
3. If needed, enable **Auto Scale** to adapt the loaded memory to fit the Multiviewer.
4. In Target, select one Multiviewer (or both).
5. Click a Multiviewer memory slot.

The Multiviewer memory is loaded to the selected Multiviewer.

Tip: It is also possible to drag a memory slot to a Multiviewer.

16.4.3 Load a Multiviewer memory at startup



Load a user defined Multiviewer memory when turning the LivePremier device on.

1. In  **Multiviewers**, click the  **Memories** tab in the right panel.
2. Click **At Startup** and select a Multiviewer memory slot to load at startup for each Multiviewer output.
3. Toggle **At Startup** to enable / disable the feature.



16.4.4 Edit a Multiviewer memory

1. Load a Multiviewer memory.
2. Click **Save** to open the memory saving window.
3. Select the Multiviewer to save.
4. Select the existing Multiviewer memory slot to edit.
5. Click **Save** to overwrite the previous Multiviewer memory.

16.4.5 Rename a Memory



1. In  **Multiviewers**, click the  **Memories** tab in the right panel.
2. Click **Edit**.
3. Click  in the top right corner of the memory slot to open the **Label** and **Color** fields.
4. Enter a new name for the memory slot.

16.4.6 Change the color of a Memory slot

1. In  **Multiviewers**, click the  **Memories** tab in the right panel.
2. Click **Edit**.
3. Click  in the top right corner of the memory slot to open the **Label** and **Color** fields.
4. Select a color for the memory slot.

Tip: To reset all memory slots to default colors, click  on top of the memory slots and click **Reset colors**.

16.4.7 Reorder memories

1. In  **Multiviewers**, click the  **Memories** tab in the right panel.
2. Click **Edit**.
3. Drag a memory slot to a new place to organize the memory slots in a custom order.

Note: Reordering memory slots does not change the memory slot number and does not impact external controllers and RC400T.

Tip: To reset to default order, click  on top of the memory slots and click **Reset order**.

17 User Maintenance and Troubleshooting

17.1 User Maintenance – Air filter

Tip: For optimal performance, this air filter must be cleaned by the user regularly (once a year).

The LivePremier unit is equipped with a removable air filter at the front of the unit.

Tools: Torx T20 screwdriver, duster or vacuum.

1. Turn the unit off and unplug mains.
2. Remove the four screws on the front panel.
3. Using both hands, gently pull the front panel on a straight axis.
4. Gently tilt it down until mechanical stop.

The front panel is in safe still position.

5. Pull the air filter and take it out from the unit.
6. Carefully clean the air filter with a duster or vacuum.
7. When the air filter is clean, gently put it back in place.
8. Gently tilt up the front panel until it is aligned.
9. Gently push the front panel back in place on a straight axis.
10. Set the screws back in place.

The air filter is cleaned and the unit is ready for use.

17.2 Troubleshooting

The Web browser cannot access the Web RCS

- Make sure to use correct network cables and that they are free from defects. (Crossover or straight cable as required).
- Check the IP address of the control computer. It must have a unique IP address on the same network as the LivePremier unit.
- Temporarily disable any other networks on the computer, such as turning off the Wi-Fi connection.
- Refresh the browser.
- Close and restart the browser.

Error: timeout of 20000ms exceeded

- Check that the anti-virus is not blocking the connection. Open your anti-virus program and add the IP address of your units as trusted connection.

Modifications triggered from RC400T do not work when synchronized

- Check that the target Preview and Program Screens are not protected by lock.

APPENDICES

Appendix A. RC400T

The **RC400T** event controller has been designed to greatly increase the level of operational efficiency and to give instant access to the crucial functionalities of the LivePremier image processor such as screens, layers, sources and memories. The RC400T offers 56 user programmable buttons, a high-resolution T-bar and a three-axis joystick for easy and fast programming (assign source in layers, load memories, etc.). The RC400T can work with the Web RCS at the same time as both selections are synchronized.

Caution: The fuse(s) present in the unit have not been designed to be replaceable. In case of problem, contact Analog Way support.



Fig. 34 - RC400T

A.a. Installation

The RC400T has been designed to be used directly on a table. It is equipped with a wrist rest and four anti-slip rubber feet. The wrist rest can be removed for a recessed installation of the RC400T.

Recessed installation - Remove the wrist rest

1. Turn the rear panel power switch off and disconnect the power supply.
2. Remove the screws of the wrist rest on both sides of the RC400T using a T10 Torx screwdriver.
3. Safely remove the wrist rest.

The RC400T is ready for recessed installation. Before embedding the RC400T, connect all cables and turn the rear panel power switch on or make sure they can be accessed.

RC400T dimensions: L 570 mm x H 122.5 mm x P 382 mm (W 22.44" x H 4.82" x D 15.04")

A.b. Controller description

A.b.a. Top area

The top area is composed of one Power button, one LCD display, one rotary encoder and two LED keys: **Confirm** and **Cancel**. This area is used mainly for configuring the RC400T (status, network, upgrade, factory reset, etc.).

Use the rotary encoder to move the selection and use the buttons to Confirm / Cancel the choices.

Note: The three-axis joystick will be fully functional in a future version.

A.b.b. XLR lamp (optional)

The XLR lamp is used to light the RC400T if needed.

To turn the lamp on, go to **Front panel settings** and enable **Power on light**.

Note: For more information on the XLR lamp for RC400T, visit www.analogway.com or contact Analog Way support.

A.b.c. Program/Preview key

Press the Program/Preview key to toggle between Program and Preview modes.

- **Program** mode is enabled when the key is on with a **red light**.
- **Preview** mode is enabled when the key is off.

Note: The **Program/Preview** key affects the entire Selection area.

A.b.d. Selection area - Multi-purpose area

The Selection area is used for Screen composition. Select Screens, Aux Screens, Layers, and assign Sources or reload Memories. The Selection area is composed of 4 identical rows of keys. Each row is composed of 12 LED keys with labels in OLED displays, one LCD key and one rotary encoder. Each row can display a predefined group of items depending on the mode selected by the user.

A.b.e. User keys area and Joystick

The User keys area is composed of 8 LED keys, one OLED display, one LCD key and one rotary encoder. This area has been designed to be evolutive and user customizable. The user keys are predefined slots for features or actions set by the user (remove a source content, set transition time, disable the T-bar, etc.).

The Joystick is used to adjust the crop, size and position of one layer. It is used together with the user keys.

Note: More features will be coming in future versions and users are welcome to request new User keys features.

A.b.f. Transition area

The Transition area is composed of one T-bar and 3 LED keys: **Take Cut**, **Step Back** and **TAKE**:

- **Take Cut** triggers an immediate transition from Preview to Program without effects or duration.
- **Step Back** reloads the former Program to the Preview.
- **TAKE** triggers the transition from Preview to Program with effects, duration, etc.

The T-bar is a manual Take triggered by the user for a smooth transition.

Note: The transition applies only to Screens selected in the Selection area.

A.b.g. RC400T rear panel



Fig. 35 - RC400T - rear panel

The rear panel is composed of:

- One power plug with a switch button
- One Ethernet plug for network connection
- One HDMI plug
- One USB plug

Note: The HDMI plug will be fully functional in a future version.

A.c. Getting started

Note: - In the Web RCS, in Dashboard > Remote Control, make sure the connection with RC400T is enabled.

- Make sure that ports 80, 443, 10591, 10606, 10691, 10692 and 10693 are available on your network and/or not blocked by firewall.

A.c.a. Start the RC400T

The RC400T controls LivePremier devices using standard Ethernet LAN networking.

1. Connect the power supply cord on the rear panel.
2. Connect the RC400T to the same network as the LivePremier unit.
3. Turn the RC400T on (rear and front On/Off buttons).

A.c.b. Turn the RC400T off

Press the On/Off button on the front panel and confirm to turn the RC400T off.

A.c.c. Configure the RC400T network

1. On the front panel, go to **Remote Device Network > Remote device LAN settings**.
2. Select a device slot, set the IP address of the LivePremier unit and Apply (192.168.2.140 by default).
3. If needed, repeat in the other device slots to add more connected units.
4. If needed, go to **Console Network**, set the IP address of the RC400T and Apply (192.168.2.130 by default).

The connection status is displayed on screen.

If the connection is not starting:

- Check that both IP addresses are on the same network and subnet.
- Check that no device has the same IP address (prevent IP conflicts).
- Check that all network configurations have been applied.
- Check that the LivePremier unit and RC400T have the latest firmware version installed.
- Check the network cables. If connecting the RC400T and the LivePremier unit directly, make sure to use an Ethernet crossover cable. If a hub or switch is involved, use straight or crossed Ethernet cables.

A.c.d. Control multiple units with the RC400T

When multiple LivePremier or Midra 4K units are enabled for remote control, the **RC400T** displays a new home page to select the device to use (by default, the active unit is the one configured in the first device slot).

- Press the **Exit/Menu** button on the Setting page to display the device selection page.

Note: - An RC400T can be connected to up to four LivePremier or Midra 4K units (only one at a time is enabled).

- A LivePremier unit can be connected to up to three RC400T controllers.

A.c.e. Firmware upgrade

Download the RC400T updater on www.analogway.com

1. Put the updater file on a USB drive.
2. Connect the USB drive on the front panel.
3. The updater file is automatically detected. Otherwise, go to **Console Control > Update from USB**.
4. Extract the updater file.
5. Install the new firmware.

Tip: It is also recommended to update the LivePremier unit with the latest firmware.

A.c.f. Reset to default values

1. On the front panel, go to **Console Control > Reset to default values**.
2. Confirm to reset the device to default values.

A.c.g. Enable / Disable the T-bar

The T-bar status is displayed in the corresponding display. The T-bar can be disabled if needed.

- On the **User keys area**, press the **T-bar Enable** key to enable / disable the T-bar.

A.d. LivePremier control with RC400T

A.d.a. Select a row mode

1. On the **Selection area**, press the LCD key of a row. The row is on Mode selection and the available modes are displayed in the OLED screens.
2. Select a mode using the corresponding LED key. The row is now in the selected mode.
3. Use the rotary encoder to change the page if needed.

Note: The same mode can be selected in different rows.

Here are some examples of configurations:

Loading Master memories (default view):

Row 1: Screens / Aux Screens

Row 2: Master memories 1 to 12 (page 1)

Row 3: Master memories 13 to 24 (page 2)

Row 4: Master memories 25 to 36 (page 3)

Assigning inputs to layers:

Row 1: Screens / Aux Screens

Row 2: Layers or Scr./Aux. Layers

Row 3: Inputs 1 to 12 (page 1)

Row 4: Inputs 13 to 24 (page 2)

A.d.b. Layer selection

The RC400T has two modes for selecting layers.

Layers	Shows all available live layers in the selected Screens as BKG Layer, Layer 1, Layer 2 , etc. This mode allows quick selection of the same layer in multiple screens. It is recommended when programming shows with lots of Screens and Layers.
Scr./Aux. Layers	Shows all available live layers in the selected Screens as S1.BKG, S1.L1, S1.L2 , etc. This mode allows selecting a single layer when multiple Screens are selected. It is recommended when programming shows with less than 36 layers in total.

Note: It is only possible to select a layer when the corresponding Screen or Aux is selected, even when using Scr./Aux. Layers mode.

Select one or multiple layer

Some of the following procedures will require to ask to select one or multiple layers.

1. On the **Selection area**, press the LCD key of a row. The row is on Mode selection.
2. Select the **Screens & Aux.** mode using the corresponding LED key. The row is on Screen mode.
3. Select the Screen using the corresponding LED key.
4. On another row, press the LCD key and select the **Layers** mode.
5. Select one or multiple layers. Use the rotary encoder to change the page if needed.

Or

1. On the **Selection area**, press the LCD key of a row. The row is on Mode selection.
2. Select the **Scr./Aux. Layers** mode using the corresponding LED key.
3. Select one or multiple layers. Use the rotary encoder to change the page if needed.

A.d.c. Assign a source to a layer

1. Select the Program or Preview mode.
2. Select one or multiple layers.
3. On another row, press the LCD key and select a source (BKG sets, Inputs or Images).
4. Select a source. Use the rotary encoder to change the page if needed.

The source is now assigned to the selected layers in the selected Screen.

Tip:

- When Background and Live layers are selected at the same time, a new source is affected only if the layer is compatible (ex: BG set to BKG layer), otherwise the source stays the same.

- When multiple live layers are selected:

- If they use the same source content, the key of the source in use is On with a solid orange color .

- If they use different contents, the key(s) of the source(s) in use is On with a weak orange color .

For more information, see *A.d.q Button color guide* page 126.

A.d.d. Remove a source from a layer

1. Select the Program or Preview mode.
2. Select one or multiple layers.
3. On the **User keys area**, press the **Source None** key.

The selected layers are cleared from any source.

A.d.e. Set a layer position and size

Note: This is only applicable to one layer. If multiple layers are selected, changes will only be applied to the layer leader (first selected).

1. Select the Program or Preview mode.
2. Select one layer.
3. On the **User keys area**, press the **Layer Pos/Size** key.
The selected layer is indicated on the display.
 - Rotate the joystick clockwise or counterclockwise to resize the layer while keeping the aspect ratio.
 - For fine adjustment, press a key to select a setting (**Pos X, Pos Y, Width or Height**), then use the rotary encoder.
 - Push the joystick to move the layer.
4. Use the **Back** key to quit the Layer Pos/Size menu.

A.d.f. Set a layer crop

Note: This is only applicable to one layer. If multiple layers are selected, changes will only be applied to the layer leader (first selected).

1. Select the Program or Preview mode.
2. Select one layer.
3. On the **User keys area**, press the **Layer Crop** key.
The selected layer is indicated on the display.
 - Rotate the joystick clockwise or counterclockwise to crop the layer equally on all sides.
 - For fine adjustment, press a key to select a side (**Top, Left, Bottom or Right**), then use the rotary encoder.
 - Push the joystick to move the crop area.
4. If needed, use the **Reset Crop** key to reset the layer crop.
5. Use the **Back** key to quit the Layer Crop menu.

A.d.g. Set an input crop

Note: Input crop replaces the input content and affects every layer using it. If needed, use layer crop or duplicate the input with a splitter.

Input crop is set by selecting the layer using the input to be cropped.

1. On the **Selection area**, press the LCD key of a row. The row is on Mode selection.
2. Select one layer.
3. Assign an input to this layer.
4. On the **User keys area**, press the **Input Crop** key.
The selected layer is indicated on the display.
 - Rotate the joystick clockwise or counterclockwise to crop the input equally on all sides.
 - For fine adjustment, press a key to select a side (**Top, Left, Bottom or Right**), then use the rotary encoder.
 - Push the joystick to move the crop area.
5. If needed, use the **Reset Crop** key to reset the input crop.
6. Use the **Back** key to quit the Input Crop menu.

A.d.h. Load a Layer memory

1. Select the Program or Preview mode.
2. Select one or multiple layers.
3. On another row, press the LCD key and select a **Layer Memories**.
4. Select a memory. Use the rotary encoder to change the page if needed.

The Layer memory is now loaded to the selected Screen.

A.d.i. Load a Screen memory

1. Select the Program or Preview mode.
2. On the **Selection area**, press the LCD key of a row. The row is on Mode selection.
3. Select the **Screens & Aux.** mode using the corresponding LED key. The row is on Screen mode.
4. Select the Screen using the corresponding LED key.
5. On another row, select the **Screen Memories** mode.
6. Select a memory. Use the rotary encoder to change the page if needed.

The Screen memory is now loaded to the selected Screen.

A.d.j. Load a Master memory

1. Select the Program or Preview mode.
2. On the **Selection area**, select the **Master Memories** mode.
3. Select a memory. Use the rotary encoder to change the page if needed.

The Master memory is now loaded to Screens as set in the Master memory.

A.d.k. Screen selection for Transitions

After loading a memory in Preview, select / deselect the Screens to transition.

1. On the **Selection area**, select the **Screens & Aux.** mode.
2. Select the Screens to transition.

Tip: To select all Screens, press the **Select Scrs&Auxs** key on the User keys area.

3. On the **User keys area**, press the **Take duration** key and use the rotary encoder to set the transition time.
4. On the **Transition area**, trigger the transition.

The selected Preview Screens are sent to Program.

A.d.l. Load a Multiviewer memory

1. On the **Selection area**, press the LCD key of a row. The row is on Mode selection.
2. Select the **Multiviewers** mode using the corresponding LED key. The row is on Multiviewers mode.
3. Select the Multiviewer output using the corresponding LED key.
4. On another row, select the **Mvw Memories** mode.
5. Select a memory. Use the rotary encoder to change the page if needed.

The Multiviewer memory is now loaded to the selected Multiviewer.

A.d.m. Save a Master Memory

Note: Saving Master Memories from the RC400T will always include all Screens, all layers and all layer properties.

1. Select the Program or Preview mode to save the corresponding Screens.
2. On the **User keys area**, press the **Memories** key.
3. Press the **Master Memories** key.
4. Use the rotary encoder to select a memory slot.
5. Press **Save**.

The Master Memory is now saved.

A.d.n. Save a Screen Memory

Note: Saving Screen Memories from the RC400T will always include all layers and all layer properties.

1. Select the Program or Preview mode to save the corresponding selection.
2. On the **Selection area**, select one Screen to save.
3. On the **User keys area**, press the **Memories** key.
4. Press the **Screen Memories** key.
5. Use the rotary encoder to select a memory slot.
6. Press **Save**.

The Screen Memory is now saved.

A.d.o. Save a Screen or Layer Memory

Note: Saving Layer Memories from the RC400T will always include all layer properties.







1. Select the Program or Preview mode to save the corresponding selection.
2. On the **Selection area**, select one Layer to save.
3. On the **User keys area**, press the **Memories** key.
4. Press the **Layer Memories** key.
5. Use the rotary encoder to select a memory slot.
6. Press **Save**.

The Layer Memory is now saved.

A.d.p. Delete a memory

1. On the **User keys area**, press the **Memories** key.
2. Press the **Master, Screen or Layer Memories** key.
3. Use the rotary encoder to select a memory slot.
4. Press the **Delete** key to delete a memory.

A.d.q. Button color guide

Button color	Description
Solid green 	<ul style="list-style-type: none"> - Element, Source or Function is available and not selected - T-bar is disabled
Solid orange 	<ul style="list-style-type: none"> - Screen, Aux or Multiviewer element is selected for edition and for transition - Master Memory is currently loaded - Screen Memory is loaded in all selected Screens - Layer Memory is loaded in all selected Layers - Layer is selected in all the selected Screens - Source element is currently used in all the selected Layers - BKG set is currently used in the all the selected Screens - T-bar is enabled
Weak orange 	<ul style="list-style-type: none"> - Screen Memory is loaded in some of the selected Screens - Layer Memory is loaded in some of the selected Layers - Layer is selected in some of the selected Screens - Source element is currently used in some of the selected Layers - BKG set is currently used in some of the selected Screens
Blinking orange 	<ul style="list-style-type: none"> - Row waiting for Mode Selection - Set transition duration
Solid red 	<ul style="list-style-type: none"> - Program mode is active - Take is available
Blinking red 	<ul style="list-style-type: none"> - Take in progress
Button Off 	<ul style="list-style-type: none"> - Preview mode is active - Element is not available

Appendix B. Other LivePremier control options

LivePremier units are also compatible with the Analog Way **Shot Box²** and **Control Box³** and also with **Companion** or **Universe** installed on a Stream deck.



B.a. Use the Shot Box² and Control Box³ with LivePremier

Analog Way Shot Box² and Control Box³ can be used to recall Memories and trigger transitions.

Tip: With the software **AW Shotbox Control**, Shot Box² and Control Box³ can also be used when connected to a computer on the same network as the LivePremier™ device.

Note: - In the Web RCS, in Dashboard > Remote Control, make sure the connection with External USB Controllers is enabled.

- The Control Box³ (SB124T-3) has been designed specifically for the latest Analog Way product lines.

The previous version, Control Box² (SB124T-2 designed for LiveCore products) is still compatible but some features are limited or not supported.

To use these controllers:

1. Connect the controller directly to the LivePremier unit via USB ports.
2. On the unit front panel, go to Control > Controller.
The reference of the controller is indicated.
The tallies indicate the connection status (● = OK ; ● = Connecting ; ● = No Connection)
3. Enable Identify to display ID on the controller (1 to 4).
4. Select the controller to open its settings:

Controller setting	Description
Enable	Enable or disable the controller
Backlight	Set the keyboard brightness (in %)
Mode*	Choose to recall Screen Memories or Master Memories
Screen*	Choose the Screen
Destination*	Choose to interact with Program or Preview
Autoscale	Enable to rescale Memory to applied Screen canvas size
Take on load	Enable to automatically trigger the transition when loading a Memory on Preview
Reset	Reset the controller configuration

*only available with the ShotBox².

5. Use the keys of the controller to recall Memories and trigger transitions.

B.b. Use the Stream deck with LivePremier

Companion and Universe are software that transform the Elgato Stream deck as a shot box that can be used with LivePremier devices.

Note: For more details, please refer to Companion or Universe documentation.

CONTACT INFORMATION

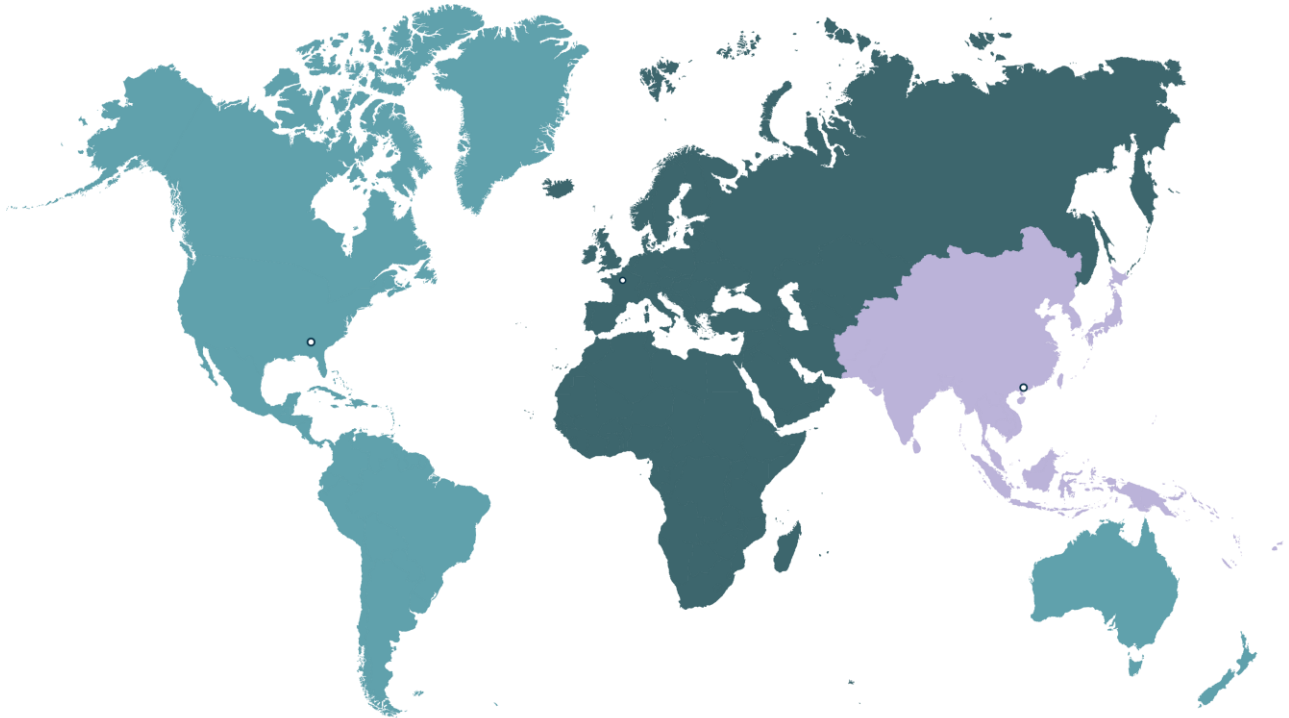
**Analog Way Inc.**

Tel.: +1 212 269 1902

3047 Summer Oak Place
Buford, GA 30518
USA

Sales/General information:

salesusa@analogway.com

Technical support:

techsupportnala@analogway.com

Analog Way SAS - Headquarters

Tel.: +33 (0)1 81 89 08 60

2/4 rue Georges Besse
92160 Antony
FRANCE

Sales/General information:

saleseuro@analogway.com

Technical support:

techsupport@analogway.com

Tel.: +33 (0)1 81 89 08 76

Analog Way Ltd

Tel.: +852 2967 0428

Office 1756, 17th Floor,
700 Nathan Road
Kowloon
Hong Kong

Sales/General information:

sales-apac@analogway.com

Technical support:

techsupport-apac@analogway.com

Connect with us on

